



---

## Wireless Remote Controller Kit

---

MODELS:

**BRC7M634F/K**

**BRC7M635F/K**

Thank you for purchasing this Daikin air conditioner.  
Carefully read this operation manual before using the air conditioner.  
It will tell you how to use the unit properly and help you if any trouble occurs.  
After reading the manual, file it away for future reference.

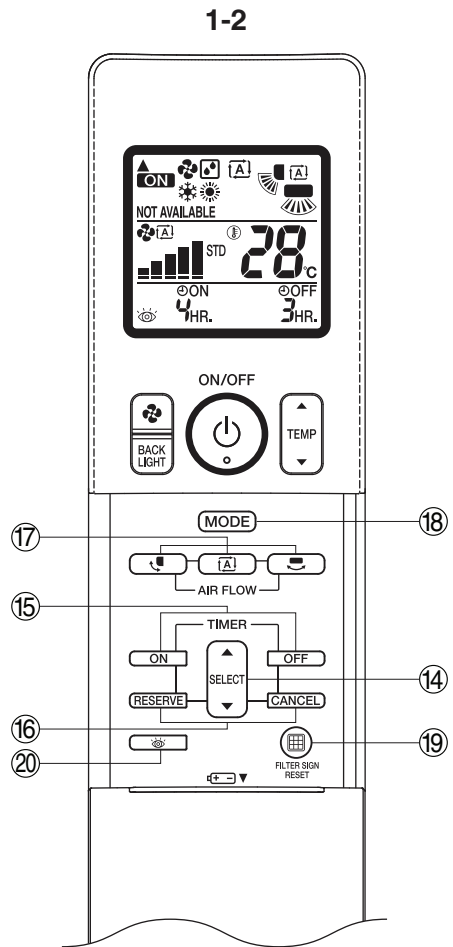
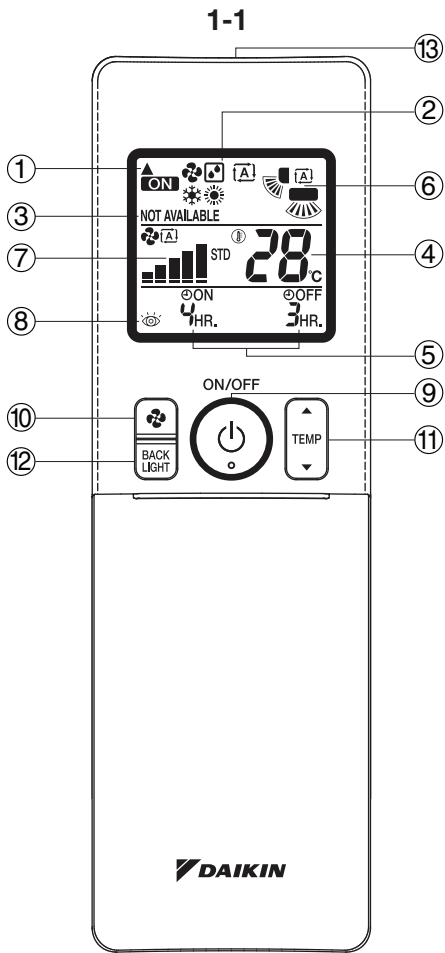

1

### COOL/HEAT CHANGEOVER REMOTE CONTROL SWITCH

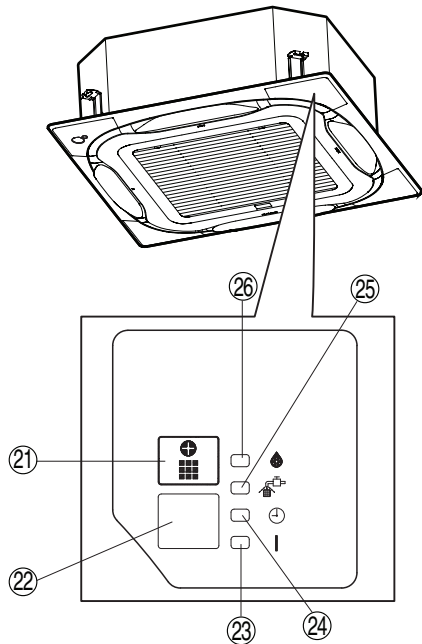
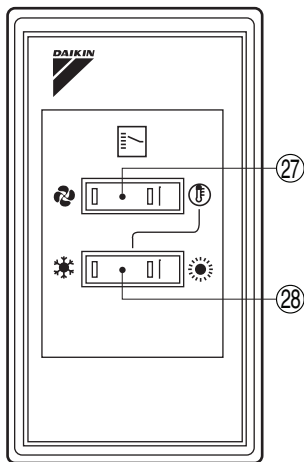

1-3

2

[1]

## **PRIOR TO USE**

This operation manual is exclusively for instructions on how to use the wireless remote controller.

Read also the operation manual attached to the indoor unit for safe usage of the system and maintenance.



## ■ Disposal requirements

Your product and the batteries supplied with the controller are marked with this symbol. This symbol means that electrical and electronic products and batteries shall not be mixed with unsorted household waste.

For batteries, a chemical symbol can be printed beneath the symbol. This chemical symbol means that the battery contains a heavy metal above a certain concentration.

Possible chemical symbols are:

### ■ Pb: lead (>0.004%)

Do not try to dismantle the system yourself: the dismantling of the product, treatment of the refrigerant, of oil and of other parts must be done by a qualified installer in accordance with relevant local and national legislation. Units and waste batteries must be treated at a specialized treatment facility for re-use, recycling and recovery.

By ensuring correct disposal, you will help to prevent potential negative consequences for the environment and human health.

Please contact the installer or local authority for more information.

# CONTENTS

ILLUSTRATION .....	[1]
PRIOR TO USE .....	[2]
1 SAFETY PRECAUTIONS.....	1
2 WHAT TO DO BEFORE OPERATION.....	4
3 NAMES AND FUNCTIONS OF THE OPERATING SECTION (Fig 1, 2).....	4
4 HANDLING FOR WIRELESS REMOTE CONTROLLER.....	5
5 OPERATION RANGE.....	7
6 INSTALLATION SITE.....	7
7 OPERATION PROCEDURE.....	7
8 OPERATION CHARACTERISTICS... ..	16
9 OPTIMUM OPERATION.....	16
10 MAINTENANCE (FOR SERVICE PERSONNEL).....	16
11 NOT MALFUNCTION OF THE AIR CONDITIONER.....	17
12 HOW TO DIAGNOSE TROUBLE SPOTS.....	17
13 HOW TO CHECK THE INITIAL SET VALUE.....	19

## 1. SAFETY PRECAUTIONS

To gain full advantage of the air conditioner's functions and to avoid malfunction due to mishandling, we recommend that you read this instruction manual carefully before use. This air conditioner is classified under "appliances not accessible to the general public".

**The precautions described herein are classified as WARNING and CAUTION. They both contain important information regarding safety. Be sure to observe all precautions without fail.**

 **WARNING** ..... Failure to follow these instructions properly may result in personal injury or loss of life.

 **CAUTION** ..... Failure to observe these instructions properly may result in property damage or personal injury, which may be serious depending on the circumstances.

After reading, keep this manual in a convenient place so that you can refer to it whenever necessary. If the equipment is transferred to a new user, be sure also to hand over the manual.

### **WARNING**

**Be aware that prolonged, direct exposure to cool or warm air from the air conditioner, or to air that is too cool or too warm can be harmful to your physical condition and health.**

**When the air conditioner is malfunctioning (giving off a burning odor, etc.) turn off power to the unit and contact your local dealer.**

Continued operation under such circumstances may result in a failure, electric shocks or fire hazards.

**Consult your local dealer to install your equipment.**

Doing the work yourself may result in water leakage, electric shocks or fire hazards.

**Consult your local dealer regarding modification, repair and maintenance of the air conditioner or the remote controller.**

Improper workmanship may result in water leakage, electric shocks or fire hazards.

**Do not place objects, including rods, your fingers, etc., in the air inlet or outlet.**

Injury may result due to contact with the air conditioner's high-speed fan blades.

**Beware of fire in case of refrigerant leakage.**

If the air conditioner is not operating correctly, i.e. not generating cool or warm air, refrigerant leakage could be the cause. Consult your dealer for assistance.

The refrigerant within the air conditioner is safe and normally does not leak.

However, in the event of a leakage, contact with a naked burner, heater or cooker may result in generation of noxious gas.

Do not longer use the air conditioner until a qualified service person confirms that the leakage has been repaired.

**Consult your local dealer regarding what to do in case of refrigerant leakage.**

When the air conditioner is to be installed in a small room, it is necessary to take proper measures so that the amount of any leaked refrigerant does not exceed the concentration limit in the event of a leakage. Otherwise, this may lead to an accident due to oxygen depletion.

**Contact professional personnel about attachment of accessories and be sure to use only accessories specified by the manufacturer.**

If a defect results from your own workmanship, it may result in water leaks, electric shock or fire.

**Consult your local dealer regarding relocation and reinstallation of the air conditioner.**

Improper installation work may result in leakage, electric shocks or fire hazards.

**Be sure to use fuses with the correct ampere reading.**

Do not use improper fuses, copper or other wires as a substitute, as this may result in electric shock, fire, injury or damage to the unit.

**Be sure to install an earth leakage breaker.**

Failure to install an earth leakage breaker may result in electric shocks or fire.

**Be sure to earth the unit.**

Do not earth the unit to a utility pipe, lightning conductor or telephone earth lead. Imperfect earthing may result in electric shocks or fire.

A high surge current from lightning or other sources may cause damage to the air conditioner.

**Consult the dealer if the air conditioner submerges owing to a natural disaster, such as a flood or typhoon.**

Do not operate the air conditioner in that case, or otherwise a malfunction, electric shock, or fire may result.

**Do not start or stop operating the air conditioner with the power supply breaker turned ON or OFF.**

Otherwise, fire or water leakage may result. Furthermore, the fan will rotate abruptly if power failure compensation is enabled, which may result in injury.

**Do not use the product in the atmosphere contaminated with oil vapor, such as cooking oil or machine oil vapor.**

Oil vapor may cause crack damage, electric shocks, or fire.

**Do not use the product in places with excessive oily smoke, such as cooking rooms, or in places with flammable gas, corrosive gas, or metal dust.**

Using the product in such places may cause fire or product failures.

**Do not use flammable materials (e.g., hairspray or insecticide) near the product.**

**Do not clean the product with organic solvents such as paint thinner.**

The use of organic solvents may cause crack damage to the product, electric shocks, or fire.

**Be sure to use a dedicated power supply for the air conditioner.**

The use of any other power supply may cause heat generation, fire, or product failures.

---

 **CAUTION**

**Do not use the air conditioner for purposes other than those for which it is intended.**

Do not use the air conditioner for cooling precision instruments, food, plants, animals or works of art as this may adversely affect the performance, quality and/or longevity of the object concerned.

**Do not remove the outdoor unit's fan guard.**

The guard protects against the unit's high speed fan, which may cause injury.

**Do not place objects that are susceptible to moisture directly beneath the indoor or outdoor units.**

Under certain conditions, condensation on the main unit or refrigerant pipes, air filter dirt or drain blockage may cause dripping, resulting in fouling or failure of the object concerned.

**To avoid oxygen depletion, ensure that the room is adequately ventilated if equipment such as a burner is used together with the air conditioner.**

**After prolonged use, check the unit stand and its mounts for damage.**

If left in a damaged condition, the unit may fall and cause injury.

**Do not place flammable sprays or operate spray containers near the unit as this may result in fire.**

**Before cleaning, be sure to stop unit operation, turn the breaker off or remove the power cord.**

Otherwise, an electric shock and injury may result.

**To avoid electric shocks, do not operate with wet hands.**

**Do not place appliances that produce naked flames in places exposed to the air flow from the unit as this may impair combustion of the burner.**

**Do not place heaters directly below the unit, as resulting heat can cause deformation.**

**Do not allow a child to mount on the outdoor unit or avoid placing any object on it.**

Falling or tumbling may result in injury.

**Do not block air inlets nor outlets.**

Impaired air flow may result in insufficient performance or trouble.

**Be sure that children, plants or animals are not exposed directly to airflow from the unit, as adverse effects may ensue.**

**Do not wash the air conditioner or the remote controller with water, as this may result in electric shocks or fire.**

**Do not place water containers (flower vases, etc.) on the unit, as this may result in electric shocks or fire.**

**Do not install the air conditioner at any place where there is a danger of flammable gas leakage.**

In the event of a gas leakage, build-up of gas near the air conditioner may result in fire hazards.

**Do not put flammable containers, such as spray cans, within 1 m from the blow-off mouth.**

The containers may explode because the warm air output of the indoor or outdoor unit will affect them.

**The batteries must be removed from the appliance before it is scrapped and they are disposed of safely.**

**Arrange the drain to ensure complete drainage.**

If proper drainage from the outdoor drain pipe does not occur during air conditioner operation, there could be a blockage due to dirt and debris build-up in the pipe.

This may result in a water leakage from the indoor unit. Under these circumstances, stop air conditioner operation and consult your dealer for assistance.

**The appliance is not intended for use by unattended young children or infirm persons.**

Impairment of bodily functions and harm to health may result.

**Children should be supervised to ensure that they do not play with the unit or its remote controller.**

Accidental operation by a child may result in impairment of bodily functions and harm health.

**Do not let children play on or around the outdoor unit.**

If they touch the unit carelessly, injury may be caused.

**Consult your dealer regarding cleaning the inside of the air conditioner.**

Improper cleaning may cause breakage of plastic parts, water leakage and other damage as well as electric shocks.

**To avoid injury, do not touch the air inlet or aluminum fins of the unit.**

**Do not place objects in direct proximity of the outdoor unit and do not let leaves and other debris accumulate around the unit.**

Leaves are a hotbed for small animals which can enter the unit. Once in the unit, such animals can cause malfunctions, smoke or fire when making contact with electrical parts.

**Never touch the internal parts of the controller.**

Do not remove the front panel. Touching certain internal parts will cause electric shocks and damage to the unit. Please consult your dealer about checking and adjustment of internal parts.

**Do not leave the remote controller wherever there is a risk of wetting.**

If water gets into the remote controller there is a risk of electrical leakage and damage to electronic components.

**When using the wireless remote controller, do not put a strong light beam or install an inverter fluorescent lamp near the receiving section on the main unit.**

A malfunction may occur.

**Watch your steps at the time of air filter cleaning or inspection.**





High-place work is required, to which utmost attention must be paid.







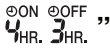

If the scaffold is unstable, you may fall or topple down, thus causing injury.

## 2. WHAT TO DO BEFORE OPERATION





Refer to the operation manual attached to the indoor unit.

## 3. NAMES AND FUNCTIONS OF THE OPERATING SECTION (Fig. 1, 2)

1	<b>DISPLAY “ ▲ ” (SIGNAL TRANSMISSION)</b>
	This blinks when a signal is being transmitted.
2	<b>DISPLAY “  ” “  ” “  ” “  ” “  ” (OPERATION MODE)</b>
	This display shows the current OPERATION MODE. Operation modes supported depend on the model that is connected.
3	<b>DISPLAY “NOT AVAILABLE” (displayed when operation is not supported)</b>
	When a button for a function that is not supported on the connected model is pressed, this displays for 2 seconds.
4	<b>DISPLAY “ <sup>STD</sup> 28 °C ” (SET TEMPERATURE)</b>
	This display shows the set temperature.

5	<b>DISPLAY “  ” (PROGRAMMED TIME)</b>
	This display shows PROGRAMMED TIME of the air conditioner start or stop.
6	<b>DISPLAY “  ” (AIRFLOW BLADE)</b>
	Refer to page 11, 12.
7	<b>DISPLAY “  ” (FAN SPEED)</b>
	The display shows the set fan speed.
8	<b>DISPLAY “  ” (INSPECTION)</b>
	When the INSPECTION BUTTON is pressed, the display shows the system mode is in. Do not operate this button during normal use.
9	<b>ON/OFF BUTTON</b>
	Press the button and the air conditioner will start. Press the button again and the air conditioner will stop.
10	<b>FAN SPEED CONTROL BUTTON</b>
	Press this button to select the fan speed.
11	<b>TEMPERATURE SETTING BUTTON</b>
	Use this button for SETTING TEMPERATURE.
12	<b>BACKLIGHT BUTTON</b>
	Press this button to turn the backlight on or off.
13	<b>SIGNAL TRANSMITTER</b>
	This sends the signals to the indoor unit.
14	<b>PROGRAMMING TIMER BUTTON</b>
	Use this button for programming “START and/or STOP” time.
15	<b>TIMER MODE ON/OFF BUTTON</b>
	Refer to page 12, 13.
16	<b>TIMER RESERVE/CANCEL BUTTON</b>
	Refer to page 13.
17	<b>AIRFLOW DIRECTION ADJUST BUTTON</b>
	Refer to page 11, 12.
18	<b>OPERATION MODE SELECTOR BUTTON</b>
	Press this button to select OPERATION MODE. “  ” (COOLING), “  ” (HEATING), “  ” (AUTOMATIC), “  ” (FAN), “  ” (PROGRAM DRY).



	<b>FILTER SIGN RESET BUTTON</b>
19	Refer to the section of MAINTENANCE in the operation manual attached to the indoor unit.
	<b>INSPECTION BUTTON</b>
20	This button is used only by qualified service persons for maintenance purposes. Do not operate this button during normal use.
	<b>EMERGENCY OPERATION SWITCH</b>
21	This switch is readily used if the remote controller does not work.
	<b>RECEIVER</b>
22	This receives the signals from the remote controller.
	<b>OPERATING INDICATOR LAMP (Red)</b>
23	This lamp stays lit while the air conditioner runs. It flashes when the unit is in trouble.
	<b>TIMER INDICATOR LAMP (Green)</b>
24	This lamp stays lit while the timer is set.
	<b>AIR FILTER CLEANING TIME INDICATOR LAMP (Red)</b>
25	Lights up when it is time to clean the air filter.
	<b>DEFROST LAMP (Orange)</b>
26	Lights up when the defrosting operation has started. (For cooling only type this lamp does not turn on.)
	<b>FAN/AIR CONDITIONING SELECTOR SWITCH</b>
27	Set the switch to “  ” (FAN) for FAN and “  ” (A/C) for HEAT or COOL.
	<b>COOL/HEAT SELECTOR SWITCH</b>
28	Set the switch to “  ” (COOL) for COOL and “  ” (HEAT) for HEAT.

## NOTES

- For the sake of explanation, all indications are shown on the display in Figure 1 contrary to actual running situations.
- Fig. 1-2 shows the remote controller with the front cover opened.
- Fig. 1-3 shows this remote controller can be used in conjunction with the one provided with the VRV system.
- If the AIR FILTER CLEANING TIME INDICATOR LAMP lights up, clean the air filter as explained in the operation manual provided with the indoor unit. After cleaning and reinstalling the air filter, press the FILTER SIGN RESET BUTTON on the remote controller. The AIR FILTER CLEANING TIME INDICATOR LAMP on the receiver will go out.
- The DEFROST OPERATION LAMP will flash when the power is turned on. This is not a malfunction.
- Do not place the remote controller where subject to direct sunlight. The display of the remote controller will get discolored and may fail to display information.

### [CAUTIONS]

**Make sure to turn off the unit and disconnect the power supply breaker when taking care of the air conditioner. Unless the power supply is disconnected, it may cause electric shocks and injuries.**

## 4. HANDLING FOR WIRELESS REMOTE CONTROLLER

### Precautions in handling remote controller

**Direct the transmitting part of the remote controller to the receiving part of the air conditioner.**

If something blocks the transmitting and receiving path of the indoor unit and the remote controller as curtains, it will not operate.

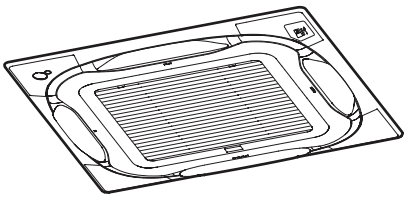

2 short beeps from the receiver indicates that the transmission is properly done.

### Types of receiving tone

The following receiving tones sound when remote controller signals are detected by the receiver.

#### 2 SHORT BEEPS:

Signal from the remote controller was received successfully.

#### 1 LONG BEEP:

(Error tone) The selected function is not supported on this indoor unit.

#### 3 SHORT BEEPS:

(Error tone) Setting/change cannot be made using this remote controller as centralised control is in operation.

### NOTE

- After settings are changed or operation is turned ON/OFF, make sure that the receiving tone of the indoor unit makes a beeping sound.

### The maximum transmitting distance is 7 to 9 m.

This depends on the installation condition of the indoor unit.

### Do not drop or get it wet.

It may be damaged.

### Never press the button of the remote controller with a hard, pointed object.

The remote controller may be damaged.

### Installation site

- It is possible that signals will not be received in room that have electronic fluorescent lighting. Please consult with your local dealer before buying new fluorescent lights.
- If the remote controller operated some other electrical apparatus, move that machine away or consult your local dealer.
- Do not install the remote controller in places exposed to direct sunlight. Doing so could result in discolouration and failure of the LCD.

### Loading the batteries

1. Slide the front cover and remove it.
2. Put 2 dry cell batteries AAA.
3. Replace the front cover.

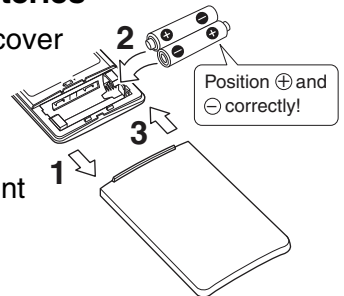

### Placing the remote controller in the remote controller holder.

Be sure to install the remote controller holder.

#### Placing the remote controller

Put it inside

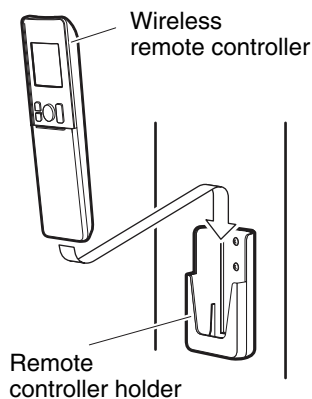

#### Removing the remote controller

Pull it upward

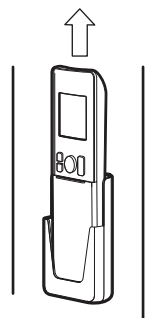

## — When to change batteries —

Under normal use, batteries last about a year. However, change them whenever the indoor unit doesn't respond or responds slowly to commands, or if the display becomes dark.

### [CAUTIONS]

- Replace all batteries at the same time, do not use new and old batteries intermixed.
- In case the remote controller is not used for a long time take out all batteries in order to prevent liquid leak of the battery.

## IN THE CASE OF CENTRALIZED CONTROL SYSTEM

If the indoor unit is under centralized control, it is necessary to switch the remote controller's setting.

In this case, contact your DAIKIN dealer.

- Do not shut off the power supply during seasonal use of the air conditioner. This is required in order to activate the air conditioner smoothly.
- If the main power supply is turned off during operation, operation will restart automatically after the power turns back on again.

## COOLING, HEATING, AUTOMATIC, FAN, AND PROGRAM DRY OPERATION

Operate in the following order.

- Operation modes supported depend on the model that is connected.
- For cooling only type, "COOLING", and "FAN" and "PROGRAM DRY" operation are able to select.

### 《《FOR SYSTEMS WITHOUT COOL/HEAT CHANGEOVER REMOTE CONTROL SWITCH》》

Refer to figure 1-1, 2 on page [1]



**Press OPERATION MODE SELECTOR button several times and select the OPERATION MODE of your choice as follows.**

- COOLING OPERATION ..... “ ❄ ”  
The recommended set temperature is 26 to 28°C.
- HEATING OPERATION ..... “ ☀ ”  
The recommended set temperature is 18 to 23°C.
- AUTOMATIC OPERATION ..... “ [A] ”
  - In this operation mode, COOL/HEAT changeover is automatically conducted.
  - AUTOMATIC OPERATION controls the temperature based on the set temperature, so it maintains a comfortable temperature throughout the year.

## 5. OPERATION RANGE

If the temperature or the humidity is beyond the operation range\*, safety devices may work and the air conditioner may not operate, or sometimes, water may drop from the indoor unit.

\*Refer to the operation range shown in the operation manual attached to the indoor or outdoor unit.

## 6. INSTALLATION SITE

Refer to operation manual attached to the indoor unit.

## 7. OPERATION PROCEDURE

Refer to figure 1 on page [1]

- Operating procedure varies with heat pump type and cooling only type. Contact your Daikin dealer to confirm your system type.
- To protect the unit, turn on the main power switch 6 hours before operation.

<Example>

When the indoor temperature decreases to 23°C or less when the set temperature is at 25°C in the AUTOMATIC COOLING OPERATION, the operation is changed over to the AUTOMATIC HEATING OPERATION. When the indoor temperature reaches 27°C or more, the operation is changed over to the AUTOMATIC COOLING OPERATION.

■ FAN OPERATION ..... “  ”  
Air in the room is circulated.

■ PROGRAM DRY OPERATION ..... “  ”

- The function of this program is to decrease the humidity in your room with the minimum temperature decrease.
- The set temperature is the indoor temperature when starting operation by PROGRAM DRY OPERATION.
- Micro computer automatically determines TEMPERATURE and FAN SPEED.
- This system does not go into operation if the room temperature is below 16°C.



**ON/OFF**

**Press ON/OFF button.**

OPERATION INDICATOR LAMP (Red) lights up or goes off and the system starts or stops OPERATION.

- The fan may keep on running for about 1 minute after the heating operation stops for removing the heat in the indoor unit.

**NOTE** 

- Do not turn OFF power immediately after the unit stops. Then, wait no less than 5 minutes.  
Water is leaking or there is something else wrong with the unit.

**<<FOR SYSTEMS WITH COOL/HEAT CHANGEVER REMOTE CONTROL SWITCH>>**

(Refer to “Switch operations on VRV system” on page 13.)

**Refer to figure 1-1,3 on page [1]**

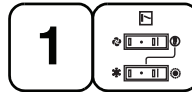

**OPERATION MODE SELECTOR**

**(1) Select OPERATION MODE with the COOL/HEAT CHANGEVER REMOTE CONTROL SWITCH as follows.**

■ COOLING OPERATION..... “  ”

■ HEATING OPERATION..... “  ”

■ FAN OPERATION ..... “  ”

■ PROGRAM DRY OPERATION.... “  ”

- See “FOR SYSTEM WITHOUT COOL/HEAT CHANGEVER REMOTE CONTROL SWITCH” for details on dry operation.

**(2) In the case of PROGRAM DRY OPERATION, press OPERATION MODE SELECTOR button on the wireless remote controller several times until “  ” appears on the display.**

**AUTOMATIC OPERATION is not available.**



**ON/OFF**

**Press ON/OFF button.**

OPERATION INDICATOR LAMP (Red) lights up or goes off and the system starts or stops OPERATION.

- The fan may keep on running for about 1 minute after the heating operation stops for removing the heat in the indoor unit.
- The air flow rate may be adjusted automatically depending on the room temperature or the fan may stop immediately. This is not a malfunction.

**NOTE** 

- Do not turn OFF power immediately after the unit stops. Then, wait no less than 5 minutes.  
Water is leaking or there is something else wrong with the unit.

## ■ CHARACTERISTICS OF THE COOLING OPERATION (COOLING OPERATION AND AUTOMATIC COOLING OPERATION)

- After continuous operation with the airflow horizontally or downward, the air conditioner operates with different airflow direction for a certain period of time to prevent condensation build-up on the airflow direction blades. (The remote controller displays the airflow direction that is set.)
- If the COOLING OPERATION is used when the indoor temperature is low, frost adheres to the heat exchanger of the indoor unit. This can decrease the cooling capacity. In this case, the system automatically switches to DEFROST OPERATION for a while.  
During DEFROST OPERATION, the low fan speed is used to prevent the discharge of melt water. (The remote controller displays the fan speed that is set.)
- When the outside temperature is high, it takes some time until the indoor temperature reaches the set temperature.

## ■ CHARACTERISTICS OF THE HEATING OPERATION (HEATING OPERATION AND AUTOMATIC HEATING OPERATION)

### START OF OPERATION

- It generally takes a longer time for indoor temperature of the HEATING OPERATION to reach the set temperature compared to the COOLING OPERATION. It is advisable to start operation in advance using the TIMER OPERATION.

### After operation is stopped

- The fan operates for about 1 minute to dispel heat inside the indoor unit.

### Perform the following operation to prevent heating capacity decrease and discharge of cool air.

## AT THE START OF OPERATION AND AFTER DEFROST OPERATION

- A warm air circulating system is employed, and therefore it takes some time until the entire room is warmed up after the start of operation.
- The indoor fan runs to discharge a gentle wind automatically until the temperature inside the air conditioner reaches a certain level. At this time, the DEFROST OPERATION LAMP on the light receiving unit indicator lights. Leave it as it stands and wait for a while.  
(The remote controller displays the fan speed that is set.)
- The air discharge direction becomes horizontal to prevent a draft of cool air to the inhabitants. (The remote controller will display the set airflow direction.)

## DEFROST OPERATION (Frost removal operation for the outdoor unit)

- As the frost on the coil of an outdoor unit increase, heating effect decreases and the system goes into the DEFROST OPERATION.
- The warm air stops, and the DEFROST OPERATION LAMP on the light receiving unit turn on. (The remote controller displays the fan speed that is set.)
- After maximum 10 minutes of the DEFROST OPERATION, the air conditioner returns to the HEATING OPERATION.
- The airflow direction becomes horizontal. (The remote controller displays the airflow direction that is set.)
- During or after the DEFROST OPERATION, white mist comes out from the air inlet or outlet of the air conditioner.
- A hissing and “Shuh” sound may be heard during this particular operation.

## Regarding outside air temperature and heating capacity

- The heating capacity of the air conditioner declines as the outside air temperature falls. In such a case, use the air conditioner in combination with other heating systems. (When a combustion appliance is used, ventilate the room regularly.)  
Do not use the combustion appliance where the air from the air conditioner is blown directly toward it.

- When the warm air stays under the ceiling and your feet are cold, we recommend that you use a circulator (a fan to circulate the air inside the room). For details, consult your local dealer.
- When the indoor temperature exceeds the set temperature, the indoor unit discharges a gentle breeze (switches to gentle wind). The airflow direction becomes horizontal. (The remote controller displays the fan speed and airflow direction that are set.)

## FAN OPERATION

- Only the fan inside the indoor unit operates, and the air in the room is circulated.

## ■ CHARACTERISTICS OF THE PROGRAM DRY OPERATION

- This operation lowers the humidity without lowering the indoor temperature. The indoor temperature when the operation button is pressed will be the set temperature. At this time, the fan speed and temperature are set automatically, so the remote controller does not display the fan speed and set temperature.  
To efficiently lower the indoor temperature and humidity, first use the COOLING OPERATION to lower the indoor temperature, and then use the PROGRAM DRY OPERATION. When the indoor temperature is lowered, airflow from the indoor unit may stop.
- When operating continuously at downward airflow direction, air blows in the automatically set direction for a period of time to prevent condensation on the horizontal blades.
- If the PROGRAM DRY OPERATION is used when the indoor temperature is low, frost forms on the heat exchanger of the indoor unit. In this case, the system automatically switches to the DEFROST OPERATION for a while.

## ADJUSTMENT

For programming TEMPERATURE, FAN SPEED and AIRFLOW DIRECTION, follow the procedure shown below.

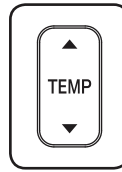

### TEMPERATURE SETTING

**Press TEMPERATURE SETTING button and program the set temperature.**

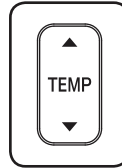

Each time this button is pressed, set temperature rises 1°C.

Each time this button is pressed, set temperature lowers 1°C.

- Temperature cannot be set in FAN OPERATION and PROGRAM DRY OPERATION modes.

### In case of AUTOMATIC OPERATION

- In AUTOMATIC OPERATION mode, the relative temperature as compared to the standard set temperature is displayed.

Remote controller display	Set temperature [°C]
STD -3	19
STD -2	20
STD -1	21
STD	22
STD +1	23
STD +2	24
STD +3	25

### NOTE

- The set temperature range of the remote controller is 16°C to 32°C.



### FAN SPEED CONTROL

**Press FAN SPEED CONTROL button.**

Fan speed can be selected.

- The micro computer may sometimes control the fan speed in order to protect the unit.
- The fan speed may be changed automatically depending on the indoor temperature.  
The fan may be stopped, but this is normal.



- It may take some time until the airflow switch is completed, but this is normal.
- Fan speeds supported depend on the model that is connected.
- In “ [A] ” (Auto), the fan speed is adjusted according to the set temperature and the temperature in the room. However, in FAN OPERATION mode, fan speed is the same as that in “High”.
- The fan speed will not be displayed if the indoor unit does not have fan speed control function.



## UP AND DOWN AIRFLOW DIRECTION ADJUSTMENT

The up/down airflow direction position switches each time the up/down airflow direction button is pressed.

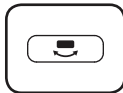
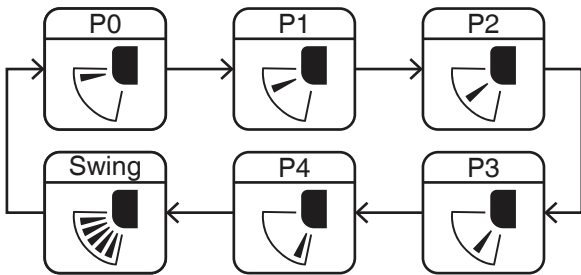

## LEFT AND RIGHT AIRFLOW DIRECTION ADJUSTMENT

The left/right airflow direction position switches each time the left/right airflow direction button is pressed.

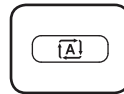
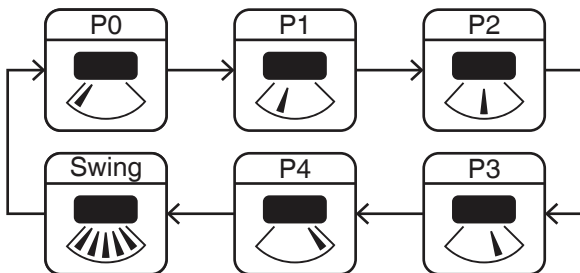

## AUTOMATIC SWITCHING OF AIRFLOW DIRECTION

The air conditioner switches to automatic airflow direction mode when the automatic airflow direction button is pressed once. When pressed again, the automatic airflow direction mode is cancelled.

### Movement of the airflow direction blades.

Under the operating conditions described below, airflow direction is controlled automatically, so it may differ from the airflow direction displayed on the remote controller.

Operating conditions	When the room temperature is higher than the set temperature (for HEATING OPERATION)	The air is blown horizontally so that the airflow is not directed at the body.
	When HEATING OPERATION starts and when in DEFROST OPERATION mode (for HEATING OPERATION)	The air is blown horizontally so that the cold airflow is not directed at the body.
	During continuous operation with the air blowing downward or horizontally	The air conditioner operates with a different airflow direction for a certain period of time to prevent condensation build-up on the airflow direction blades.

\* HEATING OPERATION mode includes cases in which operation is set to “”.



\* Since it varies by model, refer to the operation manual attached to indoor unit.

## Description of airflow direction settings and operation

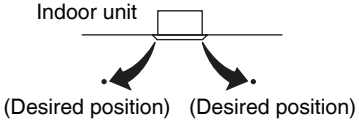
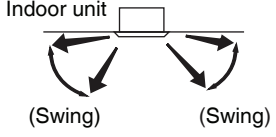
The range of movement of the airflow direction blades varies by indoor unit model. Consult the dealer of purchase for details.

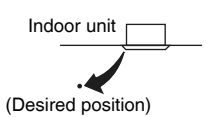
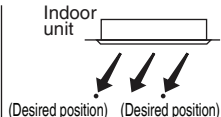
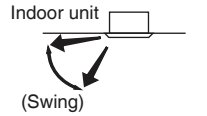
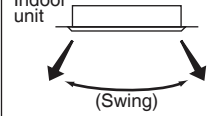
Airflow direction settings	■ Ceiling Mounted Cassette (Round Flow, 4-way Flow, 2-way Flow) ■ 4-Way Blow Ceiling Suspended Up/down airflow	
	Fixed	The airflow direction can be fixed in any position in the range Position 0 to Position 4. 
Swing	The airflow direction blades automatically move up and down within the range of Position 0 to Position 4. 	
Automatic	The airflow direction changes automatically according to the temperature of the room. However, during FAN OPERATION, the airflow direction is set to Position 0. * Depending on the model, it may not be possible to use this function.	

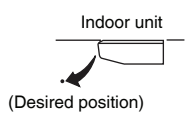
Airflow direction settings	■ Ceiling Mounted Cassette (Corner, Single Flow)	
	Up/down airflow	Left/right airflow (Single flow only)
Fixed	The airflow direction can be fixed in any position in the range Position 0 to Position 4. 	
Swing	The airflow direction blades automatically move up/down or left/right within the range of Position 0 to Position 4. 	

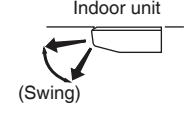
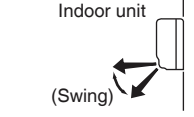
Airflow direction settings	Ceiling suspended	Wall mounted
	Up/down airflow	Up/down airflow
Fixed	The airflow direction can be fixed in any position in the range Position 0 to Position 4.  	
Swing	The airflow direction blades automatically move up and down within the range of Position 0 to Position 4.  	
Automatic	The airflow direction changes automatically according to the temperature of the room. However, during FAN OPERATION, the airflow direction is set to Position 0. * Depending on the model, it may not be possible to use this function.	

## PROGRAM TIMER OPERATION

Operate in the following order.

- The timer is operated in the following two ways.
  - Programming the stop time (⊕ OFF)
    - .... The air conditioner stops operating after the set time has elapsed.
  - Programming the start time (⊕ ON)
    - .... The air conditioner starts operating after the set time has elapsed.
- The start and the stop time can be simultaneously programmed.
- The timer setting is effective only once. When using the TIMER operation every day, the setting is required before each use.

### Setting the timer

1

ON

/

OFF

TIMER MODE ON/OFF

**Press the TIMER MODE ON/OFF button.**  
The display flashes.

For setting the timer stop .... “ ⊕ OFF ”  
For setting the timer start .... “ ⊕ ON ”



**2****PROGRAMMING TIMER**

Press the **PROGRAMMING TIMER** button and set the time for stopping or starting the air conditioner.

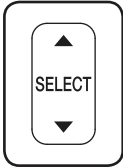

When this button is pressed, the time advances by 1 hour.

When this button is pressed, the time goes backward by 1 hour.

- Keep pressing the button to change the setting time continuously.
- The timer can be programmed a maximum of 72 hours.

**3**

RESERVE

**TIMER RESERVE**

Press the **TIMER RESERVE** button.

The timer setting procedure ends. The display changes from flashing light to a constant light.

- Make sure that the receiving tone of the indoor unit makes a beeping sound. If the receiving tone does not sound, cancel the timer according to the steps below, and then set the timer following steps **1** to **3** above again.

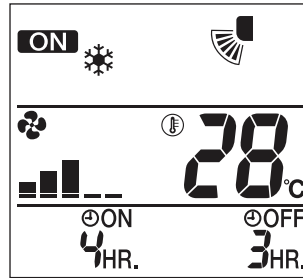
**For example.**

When the timer is programmed to stop the system after 3 hours and start the air conditioner after 4 hours, the air conditioner will stop after 3 hours and then 1 hour later the air conditioner will start.

**NOTE**

- After the timer is programmed, the display shows the remaining time.

**Switching operations on VRV system**

In the case of VRV system, the COOL/HEAT CHANGEOVER REMOTE CONTROL SWITCH may be provided for the outdoor unit (or BS unit) to allow temperature adjustment (cooling and heating) and FAN OPERATION to be switched for all indoor units at once. (Refer to **A** below)  
In systems where the COOL/HEAT CHANGEOVER REMOTE CONTROL SWITCH is not provided, the privilege to activate cool/heat operations for all indoor units can be assigned to a single indoor unit, allowing cooling and heating operations to be managed centrally. (Refer to **B** below)

**A. When the COOL/HEAT CHANGEOVER REMOTE CONTROL SWITCH is provided**

Set the COOL/HEAT CHANGEOVER REMOTE CONTROL SWITCH according to the table below before switching operations using the wireless remote controller.

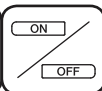
**Cancelling the timer****1****ON/OFF TIMER**

When the on **TIMER MODE ON/OFF** button is pressed, the screen display flashes as described below.

For the off timer .... “ ☉ OFF ”

For the on timer .... “ ☉ ON ”

**2**

CANCEL

**TIMER CANCEL**

When the **TIMER CANCEL** button is pressed, the timer setting that is blinking is cancelled.

- Check that the indoor unit's receiving tone beeps twice. If the receiving tone does not sound, select the timer you want to cancel again, and then cancel it.

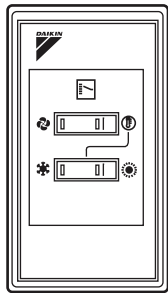
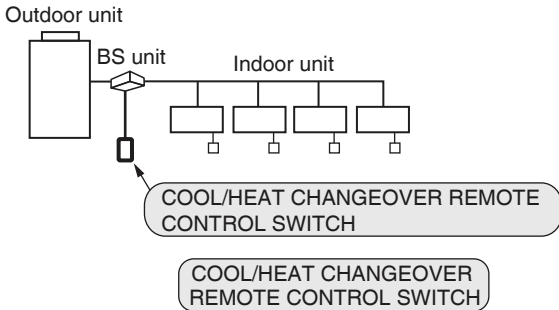
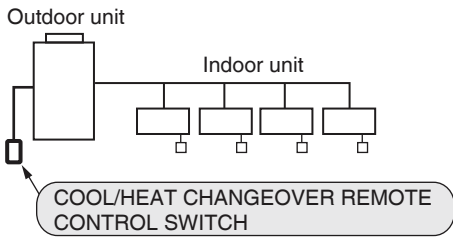

## B. When the COOL/HEAT CHANGEOVER REMOTE CONTROL SWITCH is not provided

Using the wireless remote controller, first follow the below procedure to assign the privilege to set cool/heat operations for other units to a indoor unit.

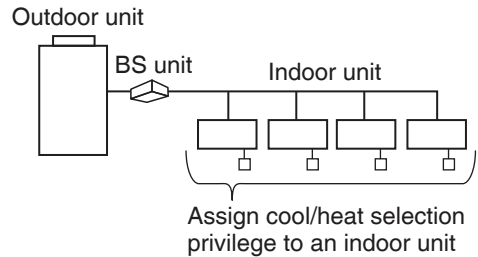
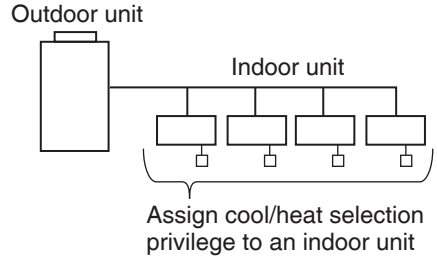

Operation modes and setting of the COOL/HEAT CHANGEOVER REMOTE CONTROL SWITCH		Operation modes that can be switched using the wireless remote controller
Cooling/ Program dry	Upper switch: ☀️ Lower switch: ❄️	Cooling/ Program dry/ Fan
Heating	Upper switch: ☀️ Lower switch: ❄️	Heating/ Fan
Fan	Upper switch: 🌀 Lower switch: —	Fan only

\* AUTOMATIC OPERATION is not possible when the COOL/HEAT CHANGEOVER REMOTE CONTROL SWITCH is provided.

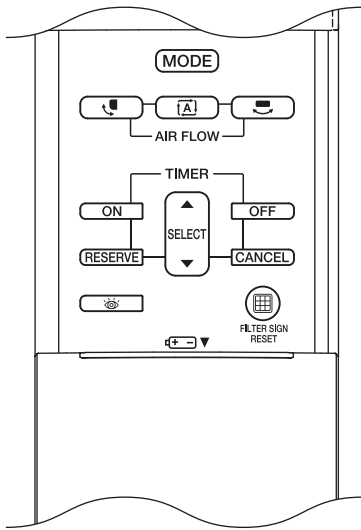

To switch the operation using the wireless remote controller, point it at the indoor unit to which cool/heat selection privilege has been assigned. The operation of the indoor units without cool/heat selection privilege switches in accordance with the operation of the indoor unit assigned with cool/heat selection privilege.

To change the cool/heat selection privilege settings, perform steps 1 to 2 again.

\* If the wireless remote controller is operated while pointed at an indoor unit without cool/heat selection privilege, operation switching cannot be performed and an error tone (long beep) will sound.

## EMERGENCY OPERATION

When the remote controller does not work due to battery failure or the absence thereof, use this switch which is located beside the discharge grille on the main unit. When the remote controller does not work, but the battery low indicator on it is not lit, contact your dealer.

### [START]

**1** To press the **EMERGENCY OPERATION SWITCH** on the receiver.

The air conditioner operates in the previous mode.

The air conditioner operates with the previously set fan speed.

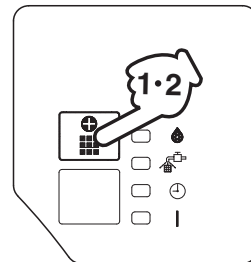

Location of this display varies by model. (Refer to figure [2] on page [1])



**Press and hold the OPERATION MODE SELECTOR button on the wireless remote controller for about 4 seconds.**

The **TIMER INDICATOR LAMP** (Green) on the displays of all the indoor units connected to the same outdoor unit or BS unit will start flashing.



**Point the wireless remote controller at the indoor unit to which cool/heat privilege is to be assigned and press the OPERATION MODE SELECTOR button again.**

Setting is complete when the **TIMER INDICATOR LAMP** (Green) on the displays of all indoor units you are trying to set stop flashing.

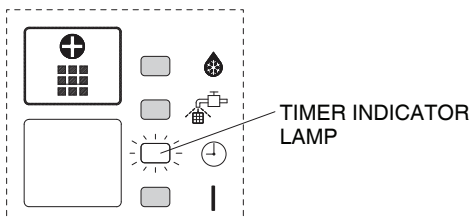

\* Layout of the display area varies by model.

## [STOP]

2

Press the **EMERGENCY OPERATION** switch again.

### PRECAUTIONS FOR GROUP CONTROL SYSTEM OR TWO REMOTE CONTROLLER CONTROL SYSTEM

This system provides two other control systems beside individual control (one remote controller controls one indoor unit) system. Confirm the following if your unit is of the following control system type.

#### ■ Group control system

One remote controller controls up to 16 indoor units.

All indoor units are equally set.

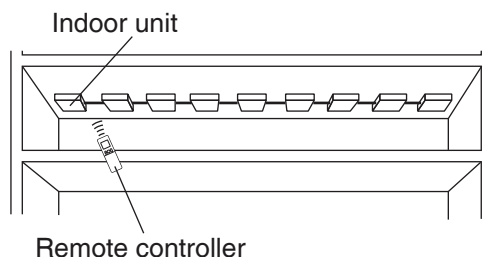

#### ■ Two remote controller control system

Two remote controllers (wired and wireless) control one indoor unit. (In case of group control system, one group of indoor units) The unit follows individual operation.

#### NOTES

- Cannot have two remote controller control system with only wireless remote controllers. (It will be a two remote controller control system having one wired and one wireless remote controllers.)
- Under two remote controller control system, wireless remote controller cannot control timer operation.
- When set the timer by the wired remote controller, the **TIMER INDICATOR LAMP** (Green) of the receiver of the indoor unit is not light up.
- If the wired remote controller is used for operation, the display on the wireless remote controller does not change.

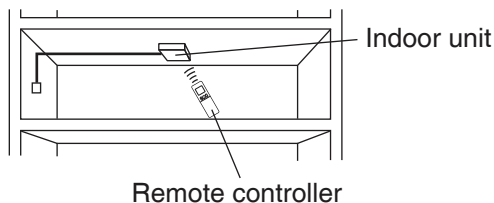

#### NOTES

- Contact your Daikin dealer in case of changing the combination or setting of group control and two remote controller control systems.
- Please do not change the combination and settings for the group operation and two remote controller control systems by yourself, but be sure to ask your local dealer.

## 8. OPERATION CHARACTERISTICS

Refer to the operation manual attached to the indoor unit.

## 9. OPTIMUM OPERATION

Refer to the operation manual attached to the indoor unit.

## 10. MAINTENANCE (FOR SERVICE PERSONNEL)

Refer to the operation manual attached to the indoor unit.

## 11. NOT MALFUNCTION OF THE AIR CONDITIONER

Refer to the operation manual attached to the indoor unit.

**And the following symptoms do not indicate air conditioner malfunction**

### I. THE AIR CONDITIONER DOES NOT OPERATE

- **The receiving tone of the indoor unit makes a triple beeping sound (normally, “beep-beep”).**

This is because the air conditioner is under centralized control.

- **After the HEATING OPERATION is started, the DEFROST OPERATION LAMP located on the indoor unit lights up.**

The indoor fan runs to discharge a gentle wind automatically until the temperature inside the air conditioner reaches a certain level. At this time, the DEFROST OPERATION LAMP on the light receiving unit indicator lights. Leave it as it stands and wait for a while.

### II. COOLING AND HEATING OPERATIONS CAN NOT BE SWITCHED

- **The receiving tone of the indoor unit makes a long beeping sound.**

An unavailable mode was set for the indoor unit under operation changeover control.

### III. THERE IS NO DISPLAY OR ALL PARTS ARE DISPLAYED

- **When a button on the remote controller is pressed.**

The batteries have run out.

- Check if the indoor unit number and wireless remote controller number are equal.

**For example.**

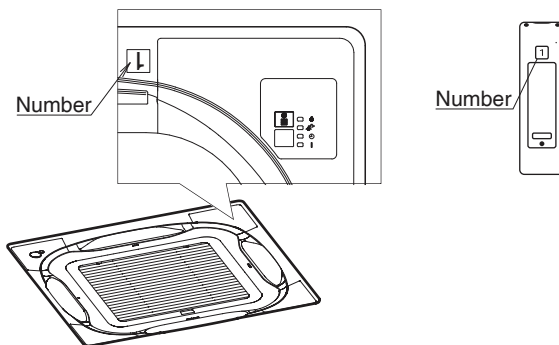

Operate the indoor unit with the remote controller of the same number. Signal transmitted from a remote controller of a different number cannot be accepted. (If the number is not mentioned, it is considered as “1”.)

### 2. The air conditioner operates but it does not sufficiently cool or heat.

- Check if the set temperature is not proper. (Refer to page 10)
- Check if the FAN SPEED is set to LOW SPEED. (Refer to page 10, 11)
- Check if the airflow direction is not proper.

(Refer to page 11, 12)

If the problem is not solved after checking the above points, please do not try to repair it yourself. In such cases, always consult your local dealer. At this time, please tell the symptom and model name (written on the manufacturer’s label).

**Contact your local dealer in the following case.**

### ⚠ WARNING

**When you detect a burning odor, shut OFF power immediately and contact your local dealer purchase. Using the equipment in anything but proper working condition can result in equipment damage, electric shock and/or a fire.**

## 12. HOW TO DIAGNOSE TROUBLE SPOTS

### I. IN CASE BESIDES EMERGENCY STOP

#### 1. The air conditioner does not operate at all.

- Check if the receiver is exposed of sunlight or strong light. Keep receiver away from light.
- Check if there are batteries in the remote controller. Place the batteries.

## II. EMERGENCY STOP

When the air conditioner stops in emergency, the OPERATING INDICATOR LAMP on the indoor unit starts blinking.

Take the following steps yourself to read the malfunction code that appears on the display.

Contact your local dealer with this code. It will help pinpoint the cause of the trouble, speeding up the repair.

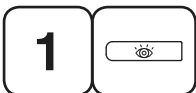
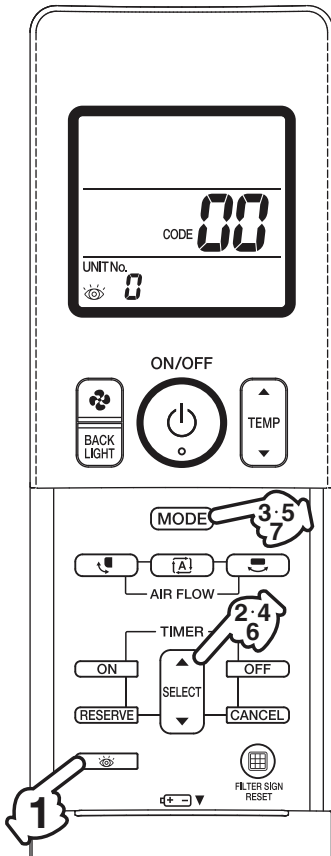

**Press the INSPECTION button to select the inspection mode “”.**

“” appears on display and blinks.

“UNIT No.” appears.



**Press PROGRAMMING TIMER button and change the unit number.**

Press to change the unit number until the indoor unit beeps and perform the following operation according to the number of beeps.

### Number of beeps

3 short beeps.....Perform all steps from **3** to **6**.

1 short beep .....Perform **3** and **6** steps.

1 long beep .....Normal state.



**Press OPERATION MODE SELECTOR button.**

“” on the left-hand of the malfunction code blinks.



**Press PROGRAMMING TIMER button and change the malfunction code.**

Press until the indoor unit beeps twice.



**Press OPERATION MODE SELECTOR button.**

“” on the right-hand of the malfunction code blinks.



**Press PROGRAMMING TIMER button and change the malfunction code.**

Press until the indoor unit makes a long beep. The malfunction code is fixed when the indoor unit makes a long beep.



## Reset of the display

Press the  button 2 times to return to normal operation mode.

Press the OPERATION MODE SELECTOR button to get the display back to the normal state.

### [Trouble]

The OPERATING INDICATOR LAMP of the indoor unit is flashing and the unit does not work at all.

(Refer to page 5, 6)

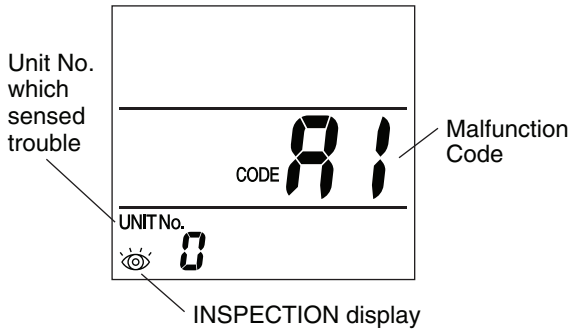

### [Remedial action]

Check the malfunction code on the remote controller and contact your local dealer.

(Refer to page 17)

## 13. HOW TO CHECK THE INITIAL SET VALUE

Further question regarding to the available functions, contact your local dealer with your initial setting value confirmed by using the remote controller with the following steps.

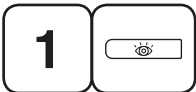

Press the INSPECTION button to select the inspection mode “”.

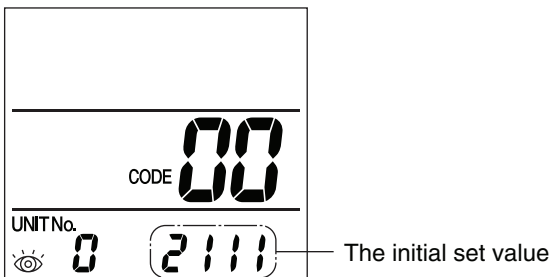

**DAIKIN INDUSTRIES, LTD.**

Head office:

Umeda Center Bldg., 2-4-12, Nakazaki-Nishi,  
Kita-ku, Osaka, 530-8323 Japan

Tokyo office:

JR Shinagawa East Bldg., 2-18-1, Konan,  
Minato-ku, Tokyo, 108-0075 Japan  
[http://www.daikin.com/global\\_ac/](http://www.daikin.com/global_ac/)

4P457484-1B M16N051A