



30XW-V

Variable-speed water-cooled screw chiller & heat pump

Cooling capacity: 567~1612kW
Heating capacity: 636~1862kW





Carrier is a leading global provider of innovative HVAC, refrigeration, fire, security and building automation technologies. Supported by the iconic Carrier name, the company's portfolio includes industry-leading brands such as Carrier, Kidde, Edwards, LenelS2 and Automated Logic. Carrier's businesses enable modern life, delivering efficiency, safety, security, comfort, productivity and sustainability across a wide

range of residential, commercial and industrial applications.

In 1998, Time magazine named Dr. Carrier one of its 20 most influential builders and titans of the 20th century.

TT Air Engineering



Nomenclature

30 XW - V 200 - PT150D

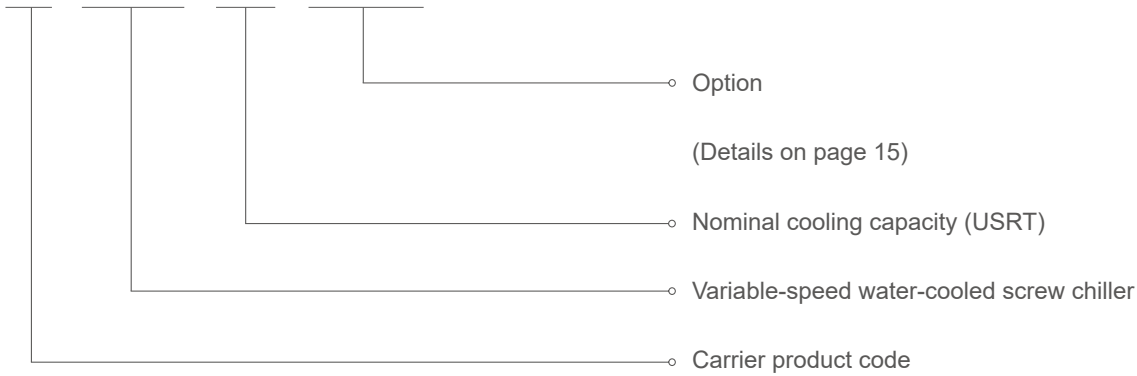

Operating Range

Cooling		
Evaporator	Minimum	Maximum
Entering temperature at start-up	-	35 C
Leaving temperature during operation	3.3 C *	20 C
Entering/leaving temperature difference at full load	2.8 C	11.1 C
Condenser		
	Minimum	Maximum
Entering temperature at start-up	13 C	-
Leaving temperature during operation	19 C	50 C **
Entering/leaving temperature difference at full load	2.8 C	11.1 C

- Note:
 1.* If the leaving water temperature is below 3.3 C , a frost protection solution must be used.
 2. ** The maximum leaving temperature differ for different model, please refer below operation envelop.
 3. During storage and transport of the unit the minimum and maximum permissible temperatures are -20 C and 58 C . These temperatures should be taken into consideration for transport by container.

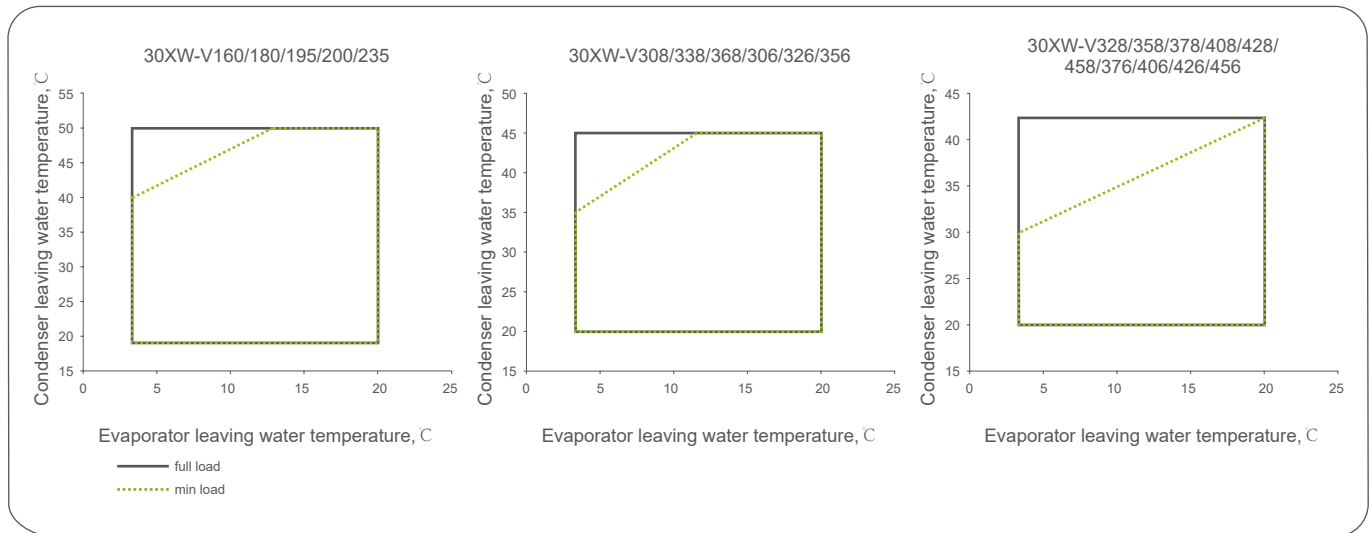

All data over 200Tons (50Hz) and all data (60Hz) in this catalogue is rated in accordance with AHRI Standard 550/590 and 551/591as represented in the Packaged Chiller Builder Selection Program (E-Cat)

General Features

The AquaForce® 30XW-V variable speed screw chillers are the premium solution for industrial and commercial applications where installers, consultants and building owners require maximum quality and optimal performances, especially at part load. They are designed to meet current and future requirements in terms of energy efficiency, versatility and compactness.

- ✔ The 30XW-V use the most reliable technologies available today:
 - Exclusive inverter-driven screw compressors, an evolution of the proven traditional Carrier twin-rotor screw compressor design.
 - Advanced Carrier® SmartVu™ controller.
 - Extremely efficient mechanically cleanable flooded evaporators.
 - Environment stewardship refrigerant HFC-134a.
- ✔ The 30XW-V range is split into two versions:
 - 30XW-V for air conditioning and refrigeration applications.
 - 30XW-V-PT150D/G for hot water and heating applications.
- ✔ As standard, the unit can provide an evaporator leaving water temperature down to 3.3 °C, and when operating as a heat pump, it can deliver up to 50 °C on the condenser side.

High Energy Efficiency

The 30XW-V was designed for high performance both at full load and at part load. Exceptional IPLV/NPLV* values set new benchmarks for low energy consumption.

- ✔ Inverter-driven twin-rotor screw compressors allow precise capacity matching of building load changes and significantly reduce unit power input, especially at part-load.
- ✔ Flooded multi-pipe evaporator and condenser for increased heat exchange efficiency.
- ✔ Electronic expansion device permits operation at a lower condensing pressure and improved utilization of the evaporator heat exchange surface.
- ✔ Inverter-driven motors ensure negligible start-up current, optimised electrical performance.

Part Load Efficiency(AHRI)

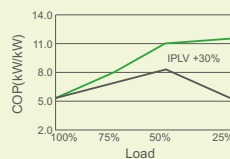

Low Start-up Current

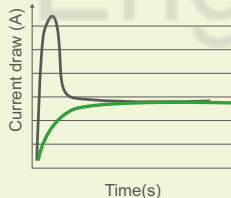

Notes: *IPLV(Integrated Part-Load Value), a single number of part-load efficiency, it's rated at 100%, 75%, 50%, and 25% load relative to the full-load rating net refrigerating capacity at the standard rating AHRI conditions. Condenser EWT is 29.4 °C, 23.8 °C, 18.3 °C, 18.3 °C, respectively. Evaporator LWT is kept constant 6.7 °C.

NPLV(Non-Standard Part-Load Value), a single number of part-load efficiency referenced to conditions other than IPLV conditions. At 100% load, the condenser EWT is user-defined, at 75% load, condenser EWT is vary linearly from the selected EWT at 100% load to 18.3 °C at 50% load, and fixed at 18.3 °C for 50% to 0% load. Evaporator LWT at each load is user-defined too.

Variable-frequency for green building design

The air conditioning system uses about 40% of the annual building energy consumption. Selection of the right air conditioning unit is one the main aspects to consider when designing a green building.

- ✔ Buildings with a variable load throughout the year 30XW-V units offer the solution to this important challenge.
- ✔ High efficiency inverter with automatic energy optimization function, optimise energy savings due to quicker commissioning and better system efficiency.
- ✔ The low total harmonic current distortion rate (THDI) options ensure that the VFD can not exceed IEEE-519 standard, for distortion at the points of commom coupling, the evaluation of the compatibility level of harmonic interference on the public low-voltage power distribution system can be done using technical report IEC61000-3-4.
- ✔ With the primary pump variable flow system, variable speed chiller and water pump unit synchronous control, to meet the energy saving demands.

Environmental Care

- ✔ Stewardship refrigerant
 - HFC-134a refrigerant with zero ozone depletion potential, has no expire date.
- ✔ Leak-tight refrigerant circuit
 - Reduction of leaks as no capillary tubes and flare connections are used.
 - Verification of pressure transducers and temperature sensors without transferring refrigerant charge.
 - Discharge line shut-off valve and liquid line service valve for simplified maintenance.

High Reliability

- ✔ Inverter-driven screw compressors
 - Industrial-type screw compressors with oversized bearings and motor cooled by suction gas.
 - The inverter is optimized for each compressor motor to ensure reliable operation and easy maintenance.
 - All compressor components are easily accessible on site minimizing down-time.
- ✔ Evaporator
 - Electronic paddle-free flow switch. Auto-setting according to cooler size and fluid type.
- ✔ Auto-adaptive control
 - Control algorithm prevents excessive compressor cycling.
 - Automatic compressor unloading in case of abnormally high condensing pressure or discharge temperature.
- ✔ Exceptional endurance tests
 - Partnerships with specialized laboratories and use of limit simulation tools (finite element calculation) for the design of critical components.
 - Transport simulation test in the laboratory on a vibrating table and then on an endurance circuit.

Easy and fast installation

- ✔ Compact design
 - The 30XW-V units are designed to offer compact dimensions for easy installation.
 - With a width of approximately 1.2 m, the units can pass through standard door openings and only require minimum floor space in the plant room.
- ✔ Simplified electrical connections
 - Main disconnect switch with high trip capacity.
 - Transformer supply to the integrated control circuit (400/24 V).
- ✔ Simplified water connections
 - Victaulic connections on the evaporator and condenser.
 - Practical reference marks for entering and leaving water connections.
 - Possibility to reverse the heat exchanger water inlet and outlet at the factory.
 - Possibility to modify the number of heat exchanger passes.
- ✔ Fast commissioning
 - Systematic factory operation test before shipment.
 - Quick-test function for step-by-step verification of the instruments, expansion devices and compressors.

AQUAFORCE greenspeed

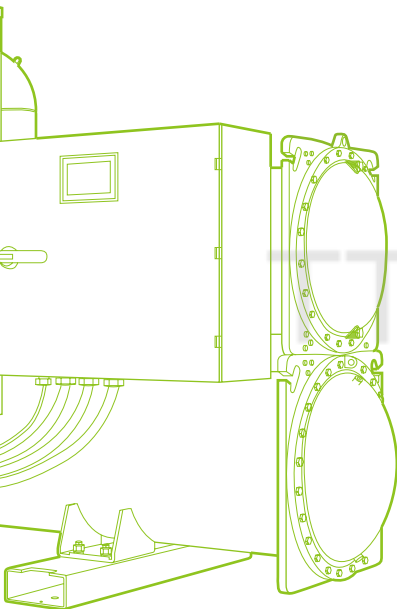

Carrier® SmartVu™ Control System - Intelligent Colored Touch Screen

- ✦ 30XW chiller employs Carrier's most advanced Carrier® SmartVu™ controller that delivers distinct capabilities of controlling and monitoring the chiller operations.
- ✦ Equipped with high-resolution colorful touch screen, Carrier® SmartVu™ controller offers more user-friendly interface with intuitive graphical operational data in real time, adapts precisely the chiller capacity to building load and provides comprehensive protection.

Reliable Start - up and Operation

- ✦ Carrier® SmartVu™ controller offers password protection to avoid any unauthorized operation.
- ✦ When chiller starts, the controller will activate pre-start process to check parameters such as pressure, temperature, motor status, water flow etc.
- ✦ In addition to the function of monitoring the main operational parameters, trending function provide the visual dynamic parameter curves. The intelligent and dynamic algorithm ensures optimal, effective and reliable chiller operation.
- ✦ The control system provides following comprehensive protection, which guarantees steady chiller operation:
 - Overcurrent.
 - Discharge temperature overheat.
 - Motor temperature overheat.
 - Evaporator and condenser anti-freeze.
 - Low discharge superheat.

Effective Failure Diagnostic

- ✦ Carrier® SmartVu™ control system has more than 100 failure diagnostic function. Users can easily access chiller operation parameters via touch screen. If control system detects failure the alarm will be initiated and related code will be recorded in alarm menu. The alarm records, up to 50, can be automatically saved by control system. Carrier service technician can read and delete alarm records by Carrier service/PCDCT tools.
- ✦ The control system can automatically send out email alarm to customer or service technician.

Intelligent Remote Connection and Control

- Carrier® SmartVu™ control panel supports CCN, BACnet IP, Modbus TCP/IP and Modbus RTU protocols, with which chiller can seamlessly connect with the Building Automation System or the i-Vu™/WebCTRL control network. Moreover, LonWorks, J-Bus and BACnet MSTP is also supported with optional gateway.
- An industrial Internet intelligent protocol module WIFI dongle housed in electrical cabinet has the function of conversion and transmission of data and can connect the field chiller controllers through the wireless network. Chiller operational data can be transmitted to the remote server (Smart Service by Carrier) via wireless network, 4G, etc., so as to monitor chiller data and fault alarm.
- Carrier Smart Service (optional) based on “Big Data Processing” provides value added customer service such as online data management and analysis, daily and key performance reports, prognostics and preventative maintenance and graphic data trend. The enhanced data management and analysis will help achieve continuous optimization of the chiller and system operation.
- Carrier Smart Service changes how equipment is serviced and maintained. Carrier service technicians now utilize mobile devices with remote access to put real-time chiller data and service history in the palm of their hands. With advance notification of problems, technicians arrive at the jobsite more informed, which leads to faster problem resolution and reduced mean time to repair.

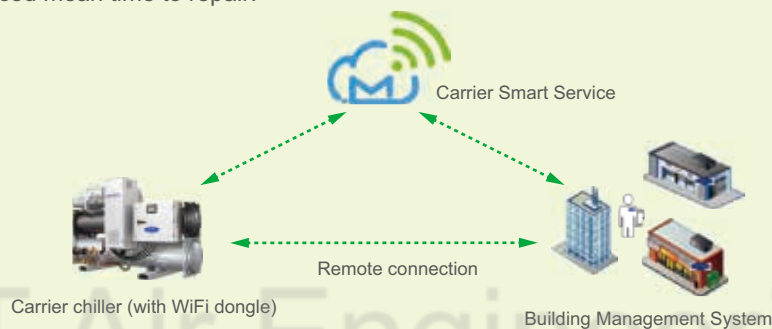

Main Page

- Control system main page operation and primary parameters monitored:

- Main page button
- Menu page button
- Log in/Language button
- Start-up/Stop page button
- Alarm menu button
- Setting point
- Chiller load percentage
- Condensing water pump status
- Chilled water pump status
- Condenser water inlet/outlet temperature
- Evaporator water inlet/outlet temperature

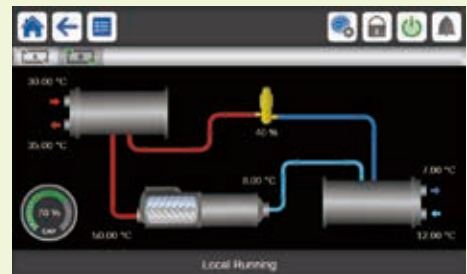

- Customer can easily read following primary information of chiller, components status and access to other interfaces from this page:

- Temperature/Pressure page
- Input/Output parameter page
- Water system parameter page
- Operation time
- Mode

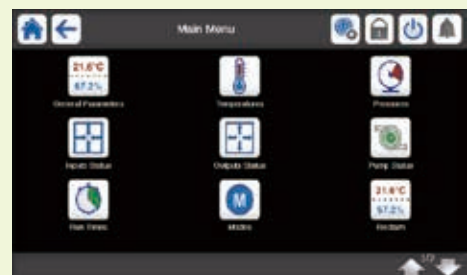

Carrier products and green building certification

Introduction

Energy usage and costs combined with increasing concerns to reduce CO₂ emissions are among the most important environmental challenges in today's world. New and existing buildings are one area where energy efficiency and the conservation of natural resources is a high priority.

Green building design

Design teams increasingly focus on designing "green buildings" to address today's energy efficiency and environmental sustainability needs. A green building is a building that is environmentally sustainable and has been designed, constructed and is operated to minimise the total impact of the environment.

The underlying principles of this approach: the resulting building will be economical to operate, offer increased comfort and create a healthier environment for the people who live and work there, increasing productivity.

The main strategies* adopted to achieve a green building design include:

- ✔ Sustainable Sites (SS)
- ✔ Water Efficiency (WE)
- ✔ Energy & Atmosphere (EA)
- ✔ Materials & Resources (MR)
- ✔ Indoor Environmental Quality (IEQ)
- ✔ Innovation in Design (ID)

Green building certification

A number of green building certification programs exist in the market and offer third-party assessment of green building measures for a wide variety of building types. Some examples of existing programs include:

- ✔ LEED (Leadership in Energy & Environmental Design)
- ✔ BREEAM
- ✔ ESTIDAMA PEARL
- ✔ NABERS (National Australian Built Environment Rating System)

HVAC products and systems

Carrier HVAC products are built to high energy efficiency and indoor air quality standards. They assist building designers and owners by offering high-performance heating, ventilation, and air conditioning (HVAC) systems and products with reduced energy consumption and enhanced indoor air quality for the occupants, contributing to optimised green building performance.

Each certification program may address and prioritise different green building design strategies according to local and regional needs and legislation. The following example looks at how Carrier's new 30XW-V range helps customers involved in LEED building certification.

* Source USGBC: LEED

Example: 30XW-V and LEED® certification

The LEED® (Leadership in Energy and Environmental Design) green building certification programme is a pre-eminent programme to rate the design, construction and operation of green buildings with points assigned in seven credit categories:

- ✔ Sustainable Sites (SS)
- ✔ Water Efficiency (WE)
- ✔ Energy & Atmosphere (EA)
- ✔ Materials & Resources (MR)
- ✔ Indoor Environmental Quality (IEQ)
- ✔ Innovation in Design (ID)
- ✔ Regional Priority (RP)

There are a number of different LEED® products. Whilst the strategies and categories assessed remain the same, the point distribution varies to address different building types and application needs, for example according to New Construction, Schools, Core & Shell, Retail and Healthcare. All programmes now use the same point scale.

The majority of credits in LEED® rating systems are performance-based and achieving them is dependent on the impacts to the overall building.

The contribution any product or system may make to the points achieved depends on how it impacts the entire building and its operations.

Whilst the LEED® green building certification programme does not certify products or services, the selection of products or service programmes is critical to obtaining LEED® certification for a registered project because the right products or service programmes can help meet the goals of green construction and ongoing operation and maintenance.

The choice of heating, ventilating and air conditioning (HVAC) products in particular can have a significant impact on LEED® certification, as the HVAC system directly impacts two categories that together influence 40% of the available points.

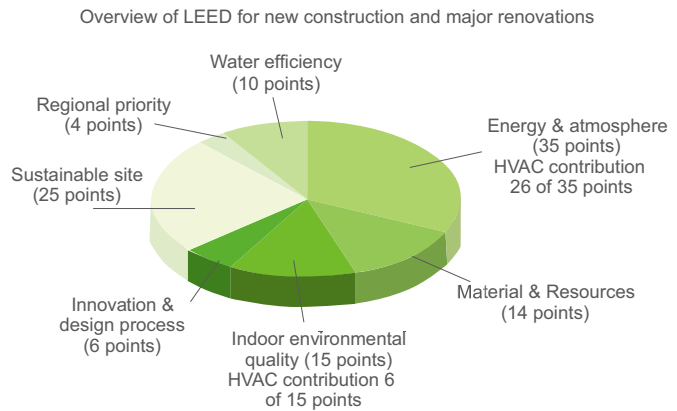
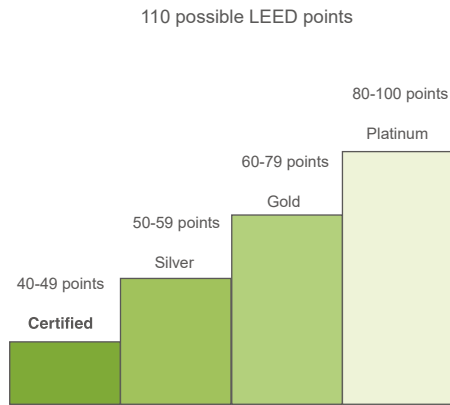

The new 30XW-V units from Carrier can assist building owners to earn LEED® points in the Energy & Atmosphere (EA) credit category and help address the following prerequisites and credit requirements:

EA prerequisite 2: Minimum Energy Performance

The 30XW-V exceeds the energy-efficiency requirements of ASHRAE 90.1-2007; therefore it complies with the prerequisite standard.

EA prerequisite 3: Fundamental Refrigerant Management

The 30XW-V does not use chlorofluorocarbon (CFC) refrigerants satisfying the prerequisite statement

EA credit 1; Optimise energy performance (1 to 19 points)

One component for this credit requires the energy cost reduction of the proposed building compared to ASHRAE 90.1-2007 minimum tables and beyond the performance level required to meet EA prerequisite 2.

The 30XW-V is designed for efficient part-load performance and therefore satisfies this LEED® credit. In addition, the Carrier HAP (Hourly Analysis Program) can be used in the energy analysis component of this credit. The HAP program can run analysis programs that comply with the modeling requirements for this credit and produce reports that are easily transferable to LEED® templates.

EA credit 4: Enhanced refrigerant management (2 points)

With this credit, LEED® awards systems that minimise the Ozone Depletion Potential (ODP) and Global Warming Potential (GWP) of the system.

The 30XW-V uses a reduced R134a charge and therefore contributes toward satisfying this credit under LEED®.

NOTE: This section describes the prerequisites and credit requirements in LEED® for New Construction and is directly related to the 30XW-V. Other prerequisites and credit requirements are not directly and purely related to the air-conditioning unit itself, but more to the control of the complete HVAC system. i-Vu™, Carrier's open control system, has features that can be valuable for:

- ✔ EA prerequisite 1: Fundamental commissioning of energy management systems
- ✔ EA credit 3: Enhanced commissioning (2 points)
- ✔ EA credit 5: Measurements and verification (3 points)

NOTE: Products are not reviewed or certified under LEED®. LEED® credit requirements cover the performance of materials in aggregate, not the performance of individual products or brands. For more information on LEED®, visit: www.usgbc.org.

Performance data

Model			30XW-V										
			160	180	195	200	235	308	328	338	368	358	378
Capacity	kW		566.6	640.7	714.9	824.0	905.0	1076.0	1148.0	1190.0	1233.0	1254.0	1339.0
	USRT		161	182	203	234	257	306	326	338	351	357	381
Full load COP@AHRI	kW/kW		5.67	5.62	5.82	5.52	5.53	5.99	6.29	5.84	5.84	6.33	6.34
IPLV@AHRI	kW/kW		9.61	9.77	9.83	9.68	9.61	10.06	9.61	10.02	10.11	9.82	9.97
Evaporator	Flow rate	L/s	24.4	27.6	30.7	35.4	38.9	46.3	49.4	51.2	53.0	53.9	57.6
	Water Pressure drop	kPa	41.7	47.8	38.1	37.8	43.0	68.3	43.0	64.5	68.3	42.1	53.2
	Water connection	DN	150	150	200	200	200	150	200	200	200	200	200
Condenser	Flow rate	L/s	30.4	34.2	38.4	44.4	48.6	58.0	62.0	64.1	66.4	67.4	72.1
	Water Pressure drop	kPa	68.1	80.6	47.1	59.8	66.5	56.9	47.8	68.3	72.0	40.2	46.8
	Water connection	DN	150	150	200	200	200	200	200	200	200	200	200
Compressor			Inverter-driven screw type										
	No.		1	1	1	1	1	1	1	1	1	1	1
Capacity control range			20%-100%										
Motor	Power	V-Ph-Hz	400-3-50/380-3-60										
	Input power	kW	99.9	113.9	122.9	149.3	163.7	179.5	182.6	203.8	211.2	198.0	211.1
Refrigerant Charge			HFC-134a										
	Circuit A	kg	135	135	180	180	180	330	380	340	340	380	400
	Circuit B	kg	-	-	-	-	-	-	-	-	-	-	-
Shipping weight*	kg	3213	3236	4188	4206	4212	6214	7653	6378	6378	7890	8240	
Operation weight	kg	3061	3084	4192	4210	4216	6384	7769	6606	6606	8083	8469	
Dimension	Length	mm	3056	3056	3301	3301	3301	4166	4107	4166	4166	4124	4515
	Width	mm	1186	1186	1264	1264	1264	1419	1536	1446	1446	1551	1551
	Height	mm	1743	1743	1949	1949	1949	2321	2563	2403	2403	2614	2614

Operation condition : Evaporator leaving water temperature 6.7 C , 0.043 l/s-kW, fouling factor=0.018m²K/kW
 Condenser entering water temperature 29.4 C , 0.054 l/s-kW, fouling factor=0.044m²K/kW

Above are recommended models. Carrier can offer more models and computer selections at required conditions. For details, please contact Carrier local agencies.

* The shipment weight is only base unit and wooden crating, excluding refrigerant and water inside.

Performance data

Model			30XW-V									
			408	428	458	306	326	356	376	406	426	456
Capacity	kW		1437.0	1497.0	1612.0	1066.0	1150.0	1245.0	1321.0	1408.0	1496.0	1584.0
	USRT		409	426	458	303	327	354	376	400	425	450
Full load COP@AHRI	kW/kW		6.22	6.25	6.32	5.36	5.42	5.42	5.47	5.46	5.47	5.42
IPLV@AHRI	kW/kW		10.10	10.00	10.09	9.46	9.68	9.67	9.48	9.48	9.42	9.43
Evaporator	Flow rate	L/s	61.8	64.4	69.3	45.8	49.5	53.5	56.8	60.6	64.3	68.1
	Water Pressure drop	kPa	45.0	48.1	49.9	36.6	42.5	31.4	34.5	39.7	45.6	51.0
	Water connection	DN	200	200	200	200	200	200	200	200	200	200
Condenser	Flow rate	L/s	77.2	80.4	86.2	57.5	62.0	67.4	71.0	75.8	80.7	85.5
	Water Pressure drop	kPa	53.0	56.5	67.6	42.3	37.4	38.1	45.9	52.1	47.1	52.2
	Water connection	DN	200	200	200	200	200	200	200	200	200	200
Compressor			Inverter-driven screw type									
	No.		1	1	1	1	1	1	1	1	1	1
Capacity control range			20%-100%									
Motor	Power	V-Ph-Hz	400-3-50/380-3-60									
	Input power	kW	231.1	239.5	255.3	198.8	212.4	229.9	241.6	258.0	273.8	292.4
Refrigerant Charge			HFC-134a									
	Circuit A	kg	400	400	400	265	295	310	280	280	280	280
	Circuit B	kg	-	-	-	-	-	-	-	-	-	-
Shipping weight*	kg		8351	8351	8447	5491	5959	6093	7274	7274	7451	7451
Operation weight	kg		8628	8628	8724	5399	5974	6200	7313	7313	7515	7515
Dimension	Length	mm	4515	4515	4515	4042	4088	4088	4107	4107	4107	4107
	Width	mm	1551	1551	1551	1419	1419	1419	1536	1536	1536	1536
	Height	mm	2614	2614	2614	2142	2251	2251	2563	2563	2563	2563

Operation condition : Evaporator leaving water temperature 6.7 C , 0.043 l/s-kW, fouling factor=0.018m²/kW

Condenser entering water temperature 29.4 C , 0.054 l/s-kW, fouling factor=0.044m²/kW

Above are recommended models. Carrier can offer more models and computer selections at required conditions. For details, please contact Carrier local agencies.

* The shipment weight is only base unit and wooden crating, excluding refrigerant and water inside.

Performance data, 30XW-V Heating units (Option)

Model			30XW-V-PT150D/G									
			160	180	195	200	235	308	328	338	368	358
Cooling												
Cooling Capacity		kW	607.6	686.2	779.7	905.0	991.2	1183.0	1258.0	1302.0	1350.0	1372.0
Input power		kW	82.3	93.1	101.6	125.2	134.4	142.1	150.4	163.0	169.1	163.8
Evaporator	Flow rate	L/s	29.0	32.8	37.3	43.2	47.4	56.5	60.1	62.2	64.5	65.6
	Water Pressure drop	kPa	55.1	63.0	59.1	59.7	67.5	102.0	63.6	95.2	101.0	62.7
Condenser	Flow rate	L/s	17.3	19.5	22.2	25.8	28.2	33.8	36.0	37.2	38.5	39.1
	Water Pressure drop	kPa	23.4	27.6	17.7	22.7	25.2	21.9	17.6	26.0	27.5	15.0
Heating												
Heating Capacity		kW	636.2	722.5	799.3	934.8	1038.0	1226.0	1288.0	1360.0	1410.0	1408.0
Input power		kW	133.3	147.4	158.3	189.8	213.0	238.3	240.9	269.6	278.0	258.9
Condenser	Flow rate	L/s	29.0	32.8	16.4	43.2	47.4	56.5	60.1	62.2	64.5	65.6
	Water Pressure drop	kPa	53.4	67.9	41.4	54.7	64.8	52.6	43.5	62.9	67.2	37.7
Evaporator	Flow rate	L/s	17.3	19.5	4.9	25.8	28.2	33.8	36.0	37.2	38.5	39.1
	Water Pressure drop	kPa	22.2	26.8	17.6	18.4	22.5	37.1	23.0	34.7	37.2	22.7
Condenser water connection		DN	150	150	200	200	200	150	200	200	200	200
Evaporator water connection		DN	150	150	200	200	200	200	200	200	200	200
Compressor			Inverter-driven screw type									
		No.	1	1	1	1	1	1	1	1	1	1
Capacity control range			20%-100%									
Power		V-Ph-Hz	400-3-50/380-3-60									
Refrigerant Charge			HFC-134a									
Circuit A		kg	135	135	180	180	180	330	380	340	340	380
Circuit B		kg	-	-	-	-	-	-	-	-	-	-
Shipping weight*		kg	3213	3236	4188	4206	4212	6214	7653	6378	6378	7890
Operation weight		kg	3061	3084	4192	4210	4216	6384	7769	6606	6606	8083
Dimension	Length	mm	3056	3056	3301	3301	3301	4166	4107	4166	4166	4124
	Width	mm	1186	1186	1264	1264	1264	1419	1536	1446	1446	1551
	Height	mm	1743	1743	1949	1949	1949	2321	2563	2403	2403	2614

1. Cooling condition: Evaporator entering/leaving water temperature -7°C, water flow rate is 0.172m³/(h.kW); Condenser entering/leaving water temperature 18/-°C, water flow rate is 0.103m³/(h.kW)
2. Heating conditions: Evaporator entering/leaving water temperature 15/-°C, water flow is equal to condenser water flow under cooling condition; Condenser entering/leaving water temperature -45°C, water flow is equal to evaporator water flow under cooling condition.
3. Evaporator fouling factor=0.018m²/K/kW, Condenser fouling factor=0.044m²/K/kW.
4. 30XW-V160 ~ 235 maximum heating temperature is 50°C, other models maximum heating temperature is 45°C.
5. Above are recommended models. Carrier can offer more models and computer selections at required conditions. For details, please contact Carrier local agencies.
6. *The shipment weight is only base unit and wooden crating, excluding refrigerant and water inside.

Performance data, 30XW-V Heating units (Option)

Model			30XW-V-PT150D/G								
			378	408	428	458	306	326	356	376	406
Cooling											
Cooling Capacity		kW	1457.0	1565.0	1626.0	1687.0	1168.0	1254.0	1355.0	1450.0	1539.0
Input power		kW	176.7	193.6	200.3	208.8	157.3	170.2	184.4	196.9	209.9
Evaporator	Flow rate	L/s	69.6	74.8	77.7	80.6	55.8	59.9	64.7	69.3	73.5
	Water Pressure drop	kPa	78.3	65.5	69.7	67.9	54.4	62.6	46.0	51.5	58.6
Condenser	Flow rate	L/s	41.6	44.6	46.3	47.8	33.4	35.8	38.8	41.3	43.9
	Water Pressure drop	kPa	17.3	19.6	20.8	23.2	16.4	15.0	15.0	18.0	20.2
Heating											
Heating Capacity		kW	1503.0	1621.0	1618.0	1862.0	1243.0	1335.0	1446.0	1525.0	1538.0
Input power		kW	275.0	299.4	292.1	335.4	259.3	278.1	300.4	319.4	315.8
Condenser	Flow rate	L/s	69.6	74.8	77.7	80.6	55.8	59.9	64.7	69.3	73.5
	Water Pressure drop	kPa	43.6	50.0	53.7	57.6	41.0	35.4	36.0	44.6	49.7
Evaporator	Flow rate	L/s	41.6	44.6	46.3	47.8	33.4	35.8	38.8	41.3	43.9
	Water Pressure drop	kPa	28.6	24.9	26.8	24.1	20.6	23.3	17.4	19.5	22.0
Condenser water connection		DN	200	200	200	200	200	200	200	200	200
Evaporator water connection		DN	200	200	200	200	200	200	200	200	200
Compressor			Inverter-driven screw type								
			No.	1	1	1	1	1	1	1	1
Capacity control range			20%-100%								
Power		V-Ph-Hz	400-3-50/380-3-60								
Refrigerant Charge			HFC-134a								
			Circuit A	kg	400	400	400	400	265	295	310
		Circuit B	kg	-	-	-	-	-	-	-	-
Shipping weight*		kg	8240	8351	8351	8447	5491	5959	6093	7274	7274
Operation weight		kg	8469	8628	8628	8724	5399	5974	6200	7313	7313
Dimension	Length	mm	4515	4515	4515	4515	4042	4088	4088	4107	4107
	Width	mm	1551	1551	1551	1551	1419	1419	1419	1536	1536
	Height	mm	2614	2614	2614	2614	2142	2251	2251	2563	2563

1. Cooling condition: Evaporator entering/leaving water temperature -7°C, water flow rate is 0.172m³/(h.kW); Condenser entering/leaving water temperature 18/-°C, water flow rate is 0.103m³/(h.kW)
2. Heating conditions: Evaporator entering/leaving water temperature 15/-°C, water flow is equal to condenser water flow under cooling condition; Condenser entering/leaving water temperature -/45°C, water flow is equal to evaporator water flow under cooling condition.
3. Evaporator fouling factor=0.018m²/K/kW, Condenser fouling factor=0.044m²/K/kW.
4. 30XW-V160 ~ 235 maximum heating temperature is 50°C, other models maximum heating temperature is 45°C.
5. Above are recommended models. Carrier can offer more models and computer selections at required conditions. For details, please contact Carrier local agencies.
6. *The shipment weight is only base unit and wooden crating, excluding refrigerant and water inside.

Electrical parameters (400V-3Ph-50Hz)

Models 30XW-V		160	180	195	200	235	308	328	338	368	358	378
Power circuit												
Rated Voltage	V-ph-Hz	400-3-50										
Voltage Range	V	360-440										
Control circuit		24 V per internal transformateur										
Power Factor												
At nominal capacity*		0.91	0.91	0.91	0.91	0.91	0.92	0.93	0.92	0.92	0.93	0.93
At maximum capacity†		0.92	0.92	0.92	0.92	0.92	0.93	0.94	0.93	0.93	0.94	0.94
Cosine phi		>0.98	>0.98	>0.98	>0.98	>0.98	>0.98	>0.98	>0.98	>0.98	>0.98	>0.98
Total Harmonic Distortion (current)††	%	40	40	40	40	40	40	40	40	40	40	40
Maximum start-up current **												
Circuit A	A	<245	<300	<300	<346	<383	<387	<360	<465	<465	<394	<409
Circuit B	A	-	-	-	-	-	-	-	-	-	-	-
Maximum power input†												
Circuit A	kW	155	193	193	222	246	249	234	300	300	257	267
Circuit B	kW	-	-	-	-	-	-	-	-	-	-	-
Nominal current draw *												
Circuit A	A	159	182	195	238	261	286	282	322	336	310	329
Circuit B	A	-	-	-	-	-	-	-	-	-	-	-
Maximum current draw (Un) †												
Circuit A	A	245	300	300	346	383	387	360	465	465	394	409
Circuit B	A	-	-	-	-	-	-	-	-	-	-	-
Maximum current draw (Un -10%) †												
Circuit A	A	270	330	330	380	421	426	379	512	512	415	431
Circuit B	A	-	-	-	-	-	-	-	-	-	-	-
Models 30XW-V		408	428	458	306	326	356	376	406	426	456	
Power circuit												
Rated Voltage	V-ph-Hz	400-3-50										
Voltage Range	V	360-440										
Control circuit		24 V per internal transformateur										
Power Factor												
At nominal capacity*		0.93	0.93	0.93	0.92	0.92	0.92	0.93	0.93	0.93	0.93	0.93
At maximum capacity†		0.94	0.94	0.94	0.93	0.93	0.93	0.94	0.94	0.94	0.94	0.94
Cosine phi		>0.98	>0.98	>0.98	>0.98	>0.98	>0.98	>0.98	>0.98	>0.98	>0.98	>0.98
Total Harmonic Distortion (current)††	%	40	40	40	40	40	40	40	40	40	40	40
Maximum start-up current **												
Circuit A	A	<423	<424	<523	<387	<465	<465	<503	<519	<530	<532	<532
Circuit B	A	-	-	-	-	-	-	-	-	-	-	-
Maximum power input†												
Circuit A	kW	275	276	341	249	300	300	327	338	345	346	346
Circuit B	kW	-	-	-	-	-	-	-	-	-	-	-
Nominal current draw *												
Circuit A	A	354	369	397	312	336	361	372	397	422	447	447
Circuit B	A	-	-	-	-	-	-	-	-	-	-	-
Maximum current draw (Un) †												
Circuit A	A	423	424	523	387	465	465	503	519	530	532	532
Circuit B	A	-	-	-	-	-	-	-	-	-	-	-
Maximum current draw (Un -10%) †												
Circuit A	A	445	446	551	426	512	512	529	546	558	560	560
Circuit B	A	-	-	-	-	-	-	-	-	-	-	-

*Values obtained at operating condition: evaporator temperature entry/leave water = 12.2°C /6.7°C , condenser temperature entry/leave water = 29.4°C /34.6°C .

**Instantaneous start -up current (locked rotor current of the largest compressor + the maximum load current of other smaller motors at maximum unit conditions).

†Values obtained at operation with maximum unit power input.

Notes, electrical data and operating condition 30XW-V units

- ✓ The control box includes the following standard features:
 - One main disconnect switch per circuit
 - Anti-short cycle protection devices
 - Control devices
- Field connections:
 - ✓ All connections to the system and the electrical installations must be in full accordance with all applicable codes. The Carrier 30XW-V units are designed and built to ensure conformance with local codes.
 - ✓ The recommendations of European standard EN 60204-1 (corresponds to IEC 60204-1)(machine safety - electrical machine components - part 1: general regulations) are specifically taken into account, when designing the electrical equipment*
 - ✓ Annex B of EN 60204-1 describes the electrical characteristics used for the operation of the machines. The ones described below apply to 30XW-V units and complement other information in this document:
 1. Physical environment**: Environment as classified in EN 60721 (corresponds to IEC 60721):
 - indoor installation
 - ambient temperature range: minimum temperature +5 °C to +42 °C , class AA4
 - altitude: lower than or equal to 2000 m
 - presence of water: class AD2 (possibility of water droplets)
 - presence of hard solids, class 4S2 (no significant dust present)
 - presence of corrosive and polluting substances, class 4C2 (negligible)
 2. Power supply frequency variation: ± 2 Hz.
 3. The neutral (N) line must not be connected directly to the unit (if necessary use a transformer).
 4. Overcurrent protection of the power supply conductors is not provided with the unit.
 5. The factory installed disconnect switch(es)/circuit breaker(s) is (are) of a type suitable for power interruption in accordance with EN 60947-3 (corresponds to IEC 60947-3).
 6. The units are designed for connection to TN networks (IEC 60364). In IT networks the use of noise filters integrated into the frequency variator(s) make machine use unsuitable. In addition, the short-circuit holding current characteristics have been modified. Provide a local earth, consult competent local organisations to complete the electrical installation.
 7. Electromagnetic environment: classification of the electromagnetic environment is described in standard EN 61800-3 (corresponds to IEC

61800-3):

- Immunity to external interference defined by the second environment*** Interference emission as defined in category C3†
- ✓ Due to the harmonic currents the integrated frequency variator in the 30XW-V units is a source of interference. An analysis may be required to verify if these interferences exceed the compatibility limits of the other devices connected to the same power supply network. The compatibility levels inside an electrical installation, that must be met at the in-plant coupling point (IPC) to which other loads are connected are described in standard 61000-2-4. Two characteristics are required for this analysis:
 - The short-circuit ratio (Rsce) of the installation calculated at the in-plant coupling point (IPC).
 - The total harmonic current distortion rate (THDI), calculated for the machine at maximum capacity.
- Note: The evaluation of the compatibility level of harmonic interference on the public lowvoltage power distribution system can be done using technical report IEC61000-3-4. In this document the THDI rate of the 30XW-V units permits a stage 2 connection procedure for any Rsce value above 350: the connection is based on the system data and the material.
- ✓ Derived currents: If protection by monitoring the leakage currents is necessary to ensure the safety of the installation, the presence of derived currents introduced by the use of frequency variators in the unit must be considered. In particular the choice the detection type and a control value not lower than 150 mA are recommended to control differential protection devices.
- NOTE: If particular aspects of an actual installation do not conform to the conditions described above, or if there are other conditions which should be considered, always contact your local Carrier representative.
- * Generally the recommendations of IEC 60364 are accepted as compliance with the requirements of the installation directives. Conformance with EN 60204-1 is the best means of ensuring compliance with the Machinery Directive.
- ** The required protection level for this class is IP21B or IPX1B (according to reference document IEC 60529). All 30XWV have IP23 units fulfil this protection condition.
- *** Example of installations of the second environment: industrial zones, technical locations supplied from a dedicated transformer.
- † Category C3 is suitable for use in an industrial environment and is not designed for use in a public low-voltage system that supplies residential locations. As an option, conformity with category C2 permits this type of installation.

Electrical parameters (380V-3Ph-60Hz)

Models 30XW-V		160	180	195	200	235	308	328	338	368	358	378
Power circuit												
Rated Voltage	V-ph-Hz	380-3-60										
Voltage Range	V	342-418										
Control circuit		24 V per internal transformateur										
Power Factor												
At nominal capacity*		0.91	0.91	0.91	0.91	0.91	0.92	0.93	0.92	0.92	0.93	0.93
At maximum capacity†		0.92	0.92	0.92	0.92	0.92	0.93	0.94	0.93	0.93	0.94	0.94
Cosine phi		>0.98	>0.98	>0.98	>0.98	>0.98	>0.98	>0.98	>0.98	>0.98	>0.98	>0.98
Total Harmonic Distortion (current)††	%	40	40	40	40	40	40	40	40	40	40	40
Maximum start-up current **												
Circuit A	A	<257	<315	<315	<363	<402	<406	<379	<488	<488	<415	<431
Circuit B	A	-	-	-	-	-	-	-	-	-	-	-
Maximum power input†												
Circuit A	kW	155	193	193	222	246	249	234	299	299	257	267
Circuit B	kW	-	-	-	-	-	-	-	-	-	-	-
Nominal current draw *												
Circuit A	A	167	191	205	251	275	302	297	340	355	327	346
Circuit B	A	-	-	-	-	-	-	-	-	-	-	-
Maximum current draw (Un) †												
Circuit A	A	257	315	315	363	402	406	379	488	488	415	431
Circuit B	A	-	-	-	-	-	-	-	-	-	-	-
Maximum current draw (Un -10%) †												
Circuit A	A	270	330	330	380	421	447	379	537	537	415	431
Circuit B	A	-	-	-	-	-	-	-	-	-	-	-
Models 30XW-V		408	428	458	306	326	356	376	406	426	456	
Power circuit												
Rated Voltage	V-ph-Hz	380-3-60										
Voltage Range	V	342-418										
Control circuit		24 V per internal transformateur										
Power Factor												
At nominal capacity*		0.93	0.93	0.93	0.92	0.92	0.92	0.93	0.93	0.93	0.93	0.93
At maximum capacity†		0.94	0.94	0.94	0.93	0.93	0.93	0.94	0.94	0.94	0.94	0.94
Cosine phi		>0.98	>0.98	>0.98	>0.98	>0.98	>0.98	>0.98	>0.98	>0.98	>0.98	>0.98
Total Harmonic Distortion (current)††	%	40	40	40	40	40	40	40	40	40	40	40
Maximum start-up current **												
Circuit A	A	<445	<446	<551	<406	<488	<488	<529	<546	<558	<560	<560
Circuit B	A	-	-	-	-	-	-	-	-	-	-	-
Maximum power input†												
Circuit A	kW	275	276	341	249	299	299	327	338	345	346	346
Circuit B	kW	-	-	-	-	-	-	-	-	-	-	-
Nominal current draw *												
Circuit A	A	372	389	418	330	355	383	392	418	444	471	471
Circuit B	A	-	-	-	-	-	-	-	-	-	-	-
Maximum current draw (Un) †												
Circuit A	A	445	446	551	406	488	488	529	546	558	560	560
Circuit B	A	-	-	-	-	-	-	-	-	-	-	-
Maximum current draw (Un -10%) †												
Circuit A	A	445	446	551	447	537	537	529	546	558	560	560
Circuit B	A	-	-	-	-	-	-	-	-	-	-	-

*Values obtained at operating condition: evaporator temperature entry/leave water = 12.2 C /6.7 C , condenser temperature entry/leave water = 29.4 C /34.6 C .

**Instantaneous start-up current (locked rotor current of the largest compressor + the maximum load current of other smaller motors at maximum unit conditions).

†Values obtained at operation with maximum unit power input.

- Notes, electrical data and operating condition 30XW-V units
- ✔ The control box includes the following standard features:
 - One main disconnect switch per circuit
 - Anti-short cycle protection devices
 - Control devices
 - ✔ Field connections:
 - All connections to the system and the electrical installations must be in full accordance with all applicable codes.
 - The Carrier 30XW-V units are designed and built to ensure conformance with local codes.
 - ✔ The recommendations of European standard EN 60204-1 (corresponds to IEC 60204-1)(machine safety - electrical machine components - part 1: general regulations) are specifically taken into account, when designing the electrical equipment*.
 - ✔ Annex B of EN 60204-1 describes the electrical characteristics used for the operation of the machines. The ones described below apply to 30XW-V units and complement other information in this document:
 1. Physical environment**: Environment as classified in EN 60721 (corresponds to IEC 60721):
 - indoor installation
 - ambient temperature range: minimum temperature +5 C to +42 C , class AA4
 - altitude: lower than or equal to 2000 m
 - presence of water: class AD2 (possibility of water droplets)
 - presence of hard solids, class 4S2 (no significant dust present)
 - presence of corrosive and polluting substances, class 4C2 (negligible)
 2. Power supply frequency variation: ± 2 Hz.
 3. The neutral (N) line must not be connected directly to the unit (if necessary use a transformer).
 4. Overcurrent protection of the power supply conductors is not provided with the unit.
 5. The factory installed disconnect switch(es)/circuit breaker(s) is (are) of a type suitable for power interruption in accordance with EN 60947-3 (corresponds to IEC 60947-3).
 6. The units are designed for connection to TN networks (IEC 60364). In IT networks the use of noise filters integrated into the frequency variator(s) make machine use unsuitable. In addition, the short-circuit holding current characteristics have been modified. Provide a local earth, consult competent local organisations to complete the electrical installation.
 7. Electromagnetic environment: classification of the electromagnetic environment is described in standard EN 61800-3 (corresponds to IEC

- 61800-3):
 - Immunity to external interference defined by the second environment***
 - Interference emission as defined in category C3†
- ✔ Due to the harmonic currents the integrated frequency variator in the 30XW-V units is a source of interference. An analysis may be required to verify if these interferences exceed the compatibility limits of the other devices connected to the same power supply network. The compatibility levels inside an electrical installation, that must be met at the in-plant coupling point (IPC) to which other loads are connected are described in standard 61000-2-4. Two characteristics are required for this analysis:
 - The short-circuit ratio (Rsce) of the installation calculated at the in-plant coupling point (IPC).
 - The total harmonic current distortion rate (THDI), calculated for the machine at maximum capacity.
- NOTE: The evaluation of the compatibility level of harmonic interference on the public lowvoltage power distribution system can be done using technical report IEC61000-3-4. In this document the THDI rate of the 30XW-V units permits a stage 2 connection procedure for any Rsce value above 350: the connection is based on the system data and the material.
- ✔ Derived currents: If protection by monitoring the leakage currents is necessary to ensure the safety of the installation, the presence of derived currents introduced by the use of frequency variators in the unit must be considered. In particular the choice the detection type and a control value not lower than 150 mA are recommended to control differential protection devices.
- NOTE: If particular aspects of an actual installation do not conform to the conditions described above, or if there are other conditions which should be considered, always contact your local Carrier representative.
- * Generally the recommendations of IEC 60364 are accepted as compliance with the requirements of the installation directives. Conformance with EN 60204-1 is the best means of ensuring compliance with the Machinery Directive.
- ** The required protection level for this class is IP21B or IPX1B (according to reference document IEC 60529). All 30XWV have IP23 units fulfil this protection condition.
- *** Example of installations of the second environment: industrial zones, technical locations supplied from a dedicated transformer.
- † Category C3 is suitable for use in an industrial environment and is not designed for use in a public low-voltage system that supplies residential locations. As an option, conformity with category C2 permits this type of installation.

Options & accessories

Options	Code	Description	Advantages	Use
Evaporator & Condenser water pressure 1.6MPa	104	Reinforced evaporator & condenser for extension of the maximum water-side service pressure to 1.6MPa	Covers applications with a high water column (high buildings)	30XW-V160~458
Evaporator & Condenser water pressure 2.1MPa	104A16	Reinforced evaporator & condenser for extension of the maximum water-side service pressure to 2.1MPa	Covers applications with a high water column (high buildings)	30XW-V160~458
Evaporator with reversed water connection	107E	Evaporator with reversed water inlet/outlet	Simplification of the water piping	30XW-V160~458
Condenser with reversed water connection	107C	Condenser with reversed water inlet/outlet	Simplification of the water piping	30XW-V160~458
CCN to J bus gateway	148B	Two way protocol converter board between CCN and J-Bus for easy connection to BMS. Consist of: - Electronic board mounted in the unit electrical cabinet - Automatic configuration at start up	Easy connection by communication bus to a building management system	30XW-V160~458
CCN to Lon work gateway	148D	Two way protocol converter board between CCN and Lon work for easy connection to BMS. Consist of: - Electronic board mounted in the unit electrical cabinet - Automatic configuration at start up	Easy connection by communication bus to a building management system	30XW-V160~458
Heat pump (Max condenser leaving temp 50°C)	150D	Heat pump control logic to control condenser LWT - Condenser insulation - Heat pump Control logic	Allows heating applications with max condenser leaving temp 50 C	30XW-V160~235
Heat pump (Max condenser leaving temp 45°C)	150G	Heat pump control logic to control condenser LWT - Condenser insulation - Heat pump Control logic	Allows heating applications with max condenser leaving temp 45 C	30XW-V308~458 (except 30XW-V426/456)
Cooling chiller condenser maximum leaving temperature 45°C	150F	Cooling chiller control logic to control condenser LWT	Avoids oversizing of the protection elements and the power cables	30XW-V328/358/378/408 /428/458/376/406/426/456
Condenser water valve control (0-10V signal)	152	Output signal (0-10V) to control the condenser water inlet valve Consist of: - One 8DO+4AI/2AO Board - Connector for 3 way valve Note: Power supply for water valve is not included Remote control module. Additional contacts for an extension of the unit control functions (without communication bus)	Used for applications with cold water at the condenser inlet (well water). In this case the valve controls the water entering temperature to maintain an acceptable condensing pressure	30XW-V160~458
Energy management module	156	Consist of: - Electronic board mounted in the unit electrical cabinet	Easy connection by wired connection to a building management system	30XW-V160~458
7 inch touch screen display	158A	Larger colorful touch screen display	Easy operation	30XW-V160~458
Evaporator flanged connections	314E	Victaulic to Flange water connections	Easy installation	30XW-V160~458
Condenser flanged connections	314C	Victaulic to Flange water connections	Easy installation	30XW-V160~458
Australia code*	312A	Meets Australia government pressure vessel code AS 1210 and AS 4343	Meets Australia government pressure vessel code AS 1210 and AS 4343	30XW-V160~458
EMC Classification according to IEC 61800-3-class C2	282	Frequency variator with RFI filter class C2	Reduces the risk of electromagnetic interference, if the unit is installed in a residential environment	30XW-V160~458
Nitrogen charge	320	Unit nitrogen factory charged	Less weight. No refrigerant charged	30XW-V160~458
Discharge shut off valve	321	Allows referigerant to be stored inside the chiller during servicing	Allows referigerant to be stored inside the chiller during servicing	30XW-V160~458
Master/Slave	58	Optimal controller could manage two units, one unit is Master and the other is slave	Master/slave control to optimize performance of two units in one plant	30XW-V160~458
Hot gas Bypass	866	Hot gas bypass minimum load down to 10%	Extend capacity operating range to match minimum load requirement	30XW-V160~458
5% Total Harmonic Current Distortion	323A	Free standing passive filter with lower 5 %THD offering	Reduce Harmonic, cleaning power source	30XW-V160~458
10% Total Harmonic Current Distortion	323B	Free standing passive filter with lower 10% THD offering	Reduce Harmonic, cleaning power source	30XW-V160~458
25% Total Harmonic Current Distortion	323C	Free standing line reactor with lower 25% THD offering	Reduce Harmonic, cleaning power source	30XW-V160~458

Notes:

1. Australia code PT312A is not compatible with PT104/PT104A16.
2. Hot gas Bypass PT866 is available only when PT321A be selected
3. Condenser water valve control option is not include 3 way valve and power supply for water valve.
4. Harmonic filter cabinet (IP54) and line reactor box (IP44) are not mounted on the chiller and need to be shipped seprately, please contact Carrier local agencies for details.

Part load performances

With the rapid increase in energy costs and the care about environmental impacts of electricity production, power consumption of air conditioning equipment has become an important topic. The energy efficiency of a liquid chiller at full load is rarely representative of the actual performance of the units, as on average a chiller works less than 5% of the time at full load.

IPLV (in accordance with AHRI 550/590)

The IPLV (integrated part load value) allows evaluation of the average energy efficiency based on four operating conditions defined by the AHRI. The IPLV is the average weighted value of the energy efficiency ratios (EER) at different operating conditions, weighted by the operating time.

IPLV (integrated part load value)

Load %	Condenser entering water temperature(C)	Energy efficiency	Operating time(%)
100	29.4	EER ₁	1
75	23.9	EER ₂	42
50	18.3	EER ₃	45
25	18.3	EER ₄	12

IPLV = EER₁ x 1% + EER₂ x 42% + EER₃ x 45% + EER₄ x 12%

The heat load of a building depends on many factors, such as the outside air temperature, the exposure to the sun and its occupation. Consequently it is preferable to use the average energy efficiency, calculated at several operating points that are representative for the unit utilisation.

ESEER (in accordance with EUROVENT)

The ESEER (European seasonal energy efficiency ratio) permits evaluation of the average energy efficiency at part load, based on four operating conditions defined by Eurovent. The ESEER is the average value of energy efficiency ratios (EER) at different operating conditions, weighted by the operating time.

ESEER (European seasonal energy efficiency ratio)

Load %	Condenser entering water temperature(C)	Energy efficiency	Operating time(%)
100	30	EER ₁	3
75	26	EER ₂	33
50	22	EER ₃	41
25	18	EER ₄	23

ESEER = EER₁ x 3% + EER₂ x 33% + EER₃ x 41% + EER₄ x 23%

Wiring Diagram

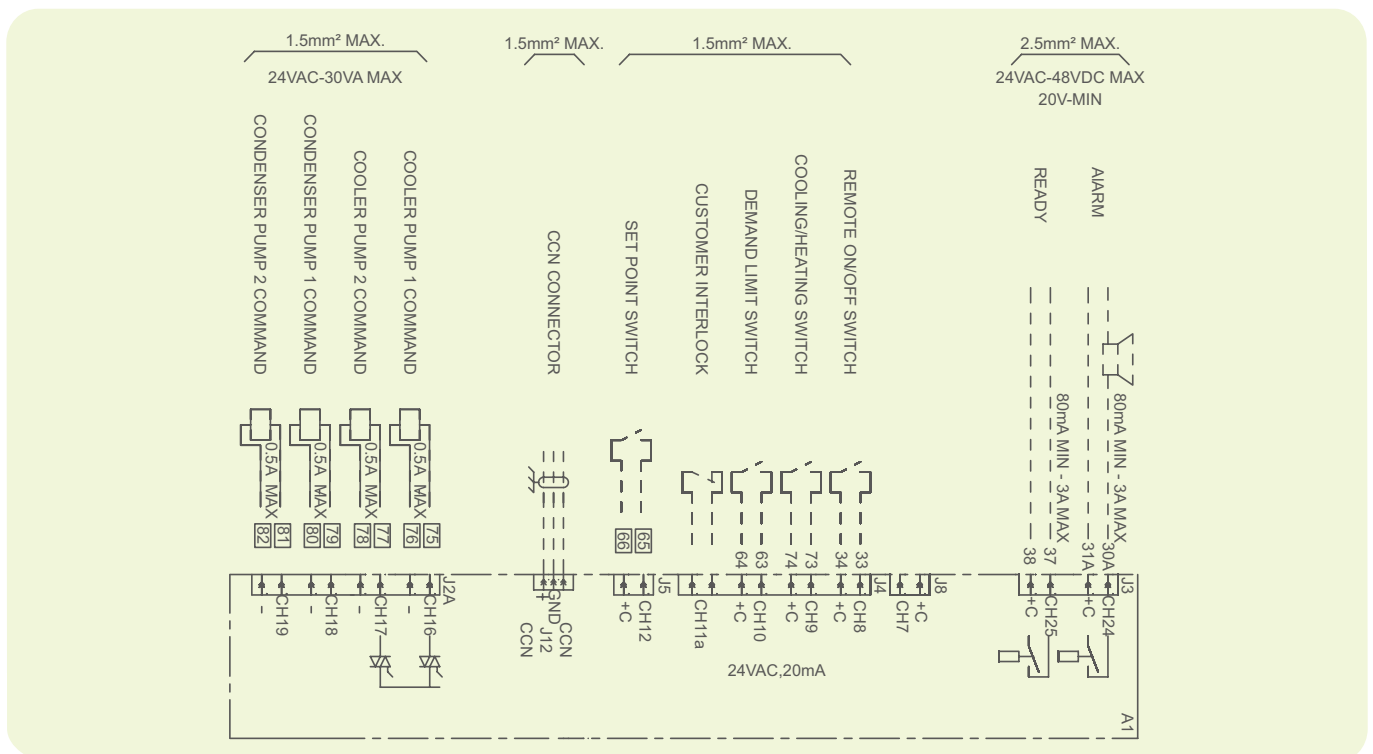

Dimension Drawing

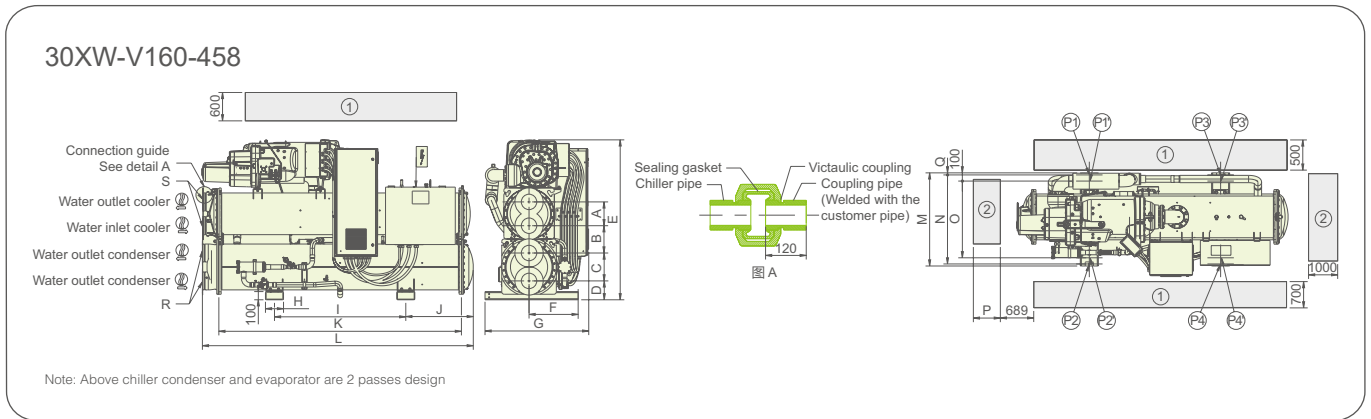

Dimension (mm)

MODEL	A	B	C	D	E	F	G	H	I	J	K	L	M	N	O	P	Q	S	R
30XW-V160	242	299	304	222	1743	539	1186	250	1200	889	2756	3056	1008	958	808	2800	25	DN150	DN150
30XW-V180	242	299	304	222	1743	539	1186	250	1200	889	2756	3056	1008	958	808	2800	25	DN150	DN150
30XW-V195	290	333	340	230	1949	687	1264	220	1600	823	2956	3301	1135	1085	935	2800	25	DN200	DN200
30XW-V200	290	333	340	230	1949	599	1264	220	1600	801	2956	3301	1135	1085	935	2800	25	DN200	DN200
30XW-V235	290	333	340	230	1949	599	1264	220	1600	801	2956	3301	1135	1085	935	2800	25	DN200	DN200
30XW-V328	340	491	360	363	2563	765	1419	250	2300	868	3660	4107	1258	1178	978	3920	40	DN200	DN200
30XW-V358	340	467	458	339	2614	765	1536	250	2300	881	3360	4124	1258	1178	978	3920	40	DN200	DN200
30XW-V378	340	467	458	339	2614	765	1551	250	2160	1148	4060	4515	1258	1178	978	3920	40	DN200	DN200
30XW-V408	340	467	458	339	2614	765	1551	250	2160	1148	4060	4515	1258	1178	978	3920	40	DN200	DN200
30XW-V428	340	467	458	339	2614	765	1551	250	2160	1148	4060	4515	1258	1178	978	3920	40	DN200	DN200
30XW-V458	340	467	458	339	2614	765	1551	250	2160	1148	4060	4515	1258	1178	978	3920	40	DN200	DN200
30XW-V306	340	389	340	322	2142	707	1419	250	2160	912	3656	4042	1231	1151	951	3920	40	DN200	DN200
30XW-V326	340	435	360	363	2251	725	1419	250	2160	933	3660	4088	1258	1178	978	3920	40	DN200	DN200
30XW-V356	340	435	360	363	2251	725	1419	250	2160	933	3660	4088	1258	1178	978	3920	40	DN200	DN200
30XW-V376	340	491	360	363	2563	765	1536	250	2300	868	3660	4107	1258	1178	978	3920	40	DN200	DN200
30XW-V406	340	491	360	363	2563	765	1536	250	2300	868	3660	4107	1258	1178	978	3920	40	DN200	DN200
30XW-V426	340	491	360	363	2563	765	1536	250	2300	868	3660	4107	1258	1178	978	3920	40	DN200	DN200
30XW-V456	340	491	360	363	2563	765	1536	250	2300	868	3660	4107	1258	1178	978	3920	40	DN200	DN200

Weight distribution (kg)

MODEL	P1	P2	P3	P4	P1*	P2*	P3*	P4*	PT
30XW-V160	963	956	573	569	963	955	574	569	3061
30XW-V180	970	963	578	574	971	962	578	573	3084
30XW-V195	1426	1445	656	665	1424	1447	656	665	4192
30XW-V200	1324	1578	597	711	1311	1591	591	717	4210
30XW-V235	1326	1580	597	712	1313	1593	592	718	4216
30XW-V328	2536	2338	1506	1389	2557	2317	1518	1377	7769
30XW-V358	2632	2426	1575	1450	2653	2404	1587	1439	8083
30XW-V378	2760	2544	1647	1518	2783	2522	1660	1504	8469
30XW-V408	2813	2575	1692	1548	2838	2550	1706	1534	8628
30XW-V428	2813	2575	1692	1548	2838	2550	1706	1534	8628
30XW-V458	2945	2742	1573	1464	2965	2721	1584	1454	8724
30XW-V306	1879	1793	884	843	1888	1784	888	839	5399
30XW-V326	2127	1941	996	909	2147	1922	1005	900	5974
30XW-V356	2208	2014	1034	944	2228	1995	1043	934	6200
30XW-V376	2522	2301	1302	1188	2545	2278	1314	1176	7313
30XW-V406	2522	2301	1302	1188	2545	2278	1314	1176	7313
30XW-V426	2575	2440	1284	1216	2590	2426	1290	1209	7515
30XW-V456	2575	2440	1284	1216	2590	2426	1290	1209	7515

Note:

- Tolerances on nozzle locations and overall dimensions are ± 25 mm.
- ① Required clearances for maintenance, ② Recommended space for tube removal
- Pi and Pi' are two group of bolts to fix the chiller, either group can be selected.
- The water pipe connector is the Victaulic coupling, the Victaulic and the pipe are supplied with the chiller, the pipe length is 120mm.

Dimension Drawing

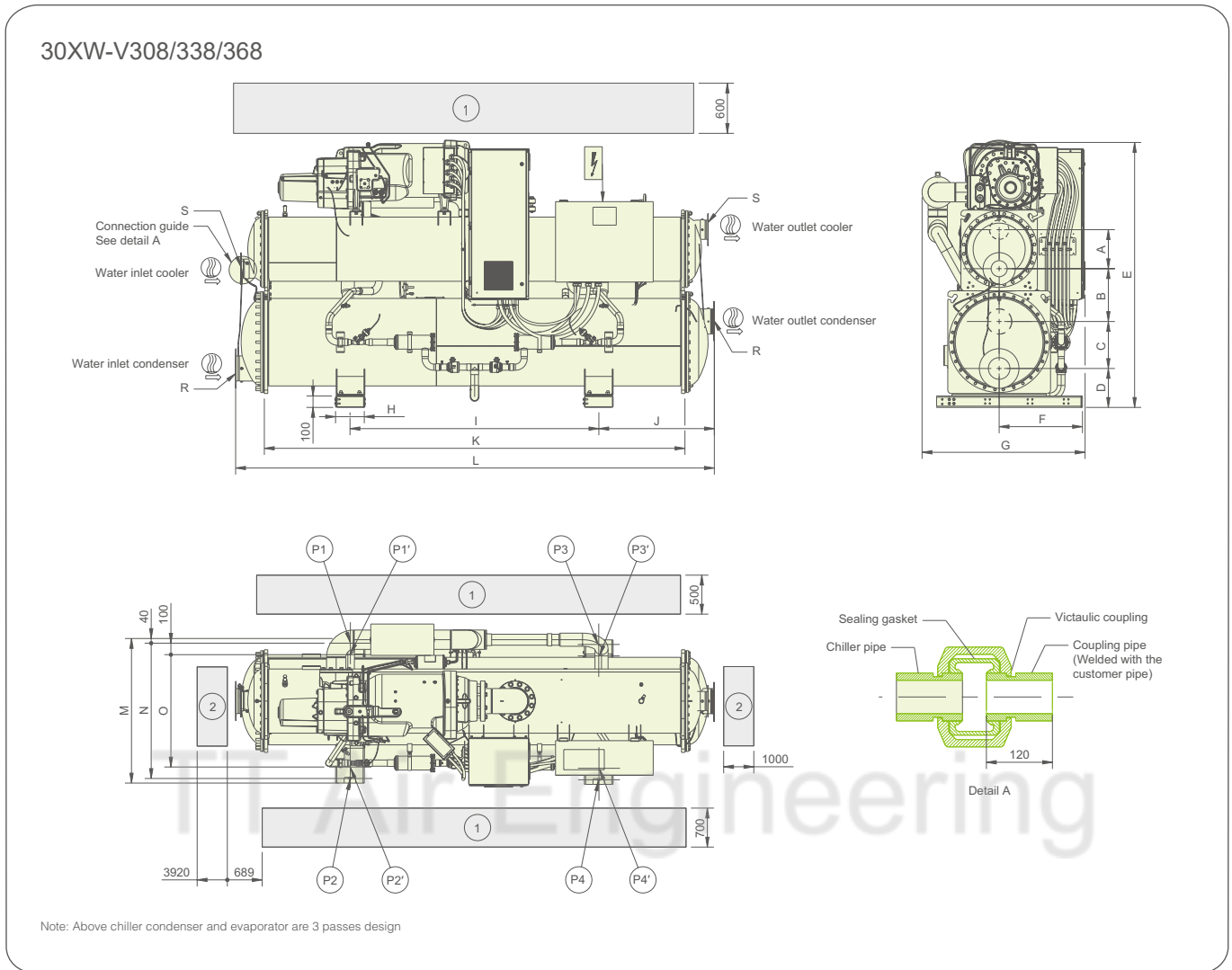

Dimension (mm)

MODEL	A	B	C	D	E	F	G	H	I	J	K	L	M	N	O	S	R
30XW-V308	339	456	413	339	2321	725	1419	250	2165	1005	3660	4166	1258	1178	978	DN150	DN200
30XW-V338	392	491	409	339	2403	734	1446	250	2165	1005	3660	4166	1258	1178	978	DN200	DN200
30XW-V368	392	491	409	339	2403	734	1446	250	2165	1005	3660	4166	1258	1178	978	DN200	DN200

Weight distribution (kg)

MODEL	P1	P2	P3	P4	P1'	P2'	P3'	P4'	PT
30XW-V308	2207	2034	1116	1028	2224	2016	1124	1019	6384
30XW-V338	2309	2078	1168	1051	2333	2055	1179	1039	6606
30XW-V368	2309	2078	1168	1051	2333	2055	1179	1039	6606

Note:

- Tolerances on nozzle locations and overall dimensions are ± 25 mm.
- ① Required clearances for maintenance, ② Recommended space for tube removal
- P1 and P1' are two group of bolts to fix the chiller, either group can be selected.
- The water pipe connector is the Victaulic coupling, the Victaulic and the pipe are supplied with the chiller, the pipe length is 120mm.

Basement Drawing

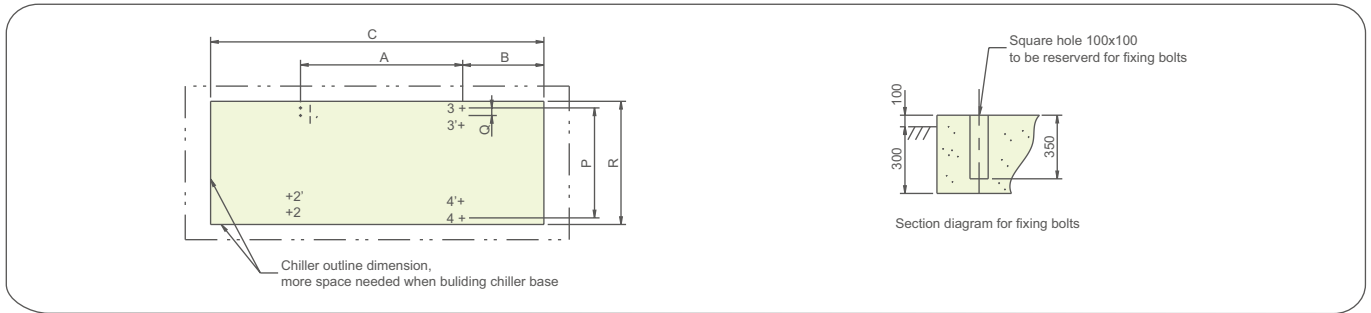

MODEL	A(mm)	B(mm)	C(mm)	P(mm)	Q(mm)	R(mm)
30XW-V160	1200	889	3056	958	75	1186
30XW-V180	1200	889	3056	958	75	1186
30XW-V195	1600	823	3301	1085	75	1264
30XW-V200	1600	801	3301	1085	75	1264
30XW-V235	1600	801	3301	1085	75	1264
30XW-V308	2165	1005	4166	1258	100	1419
30XW-V328	2300	868	4107	1258	100	1536
30XW-V338	2165	1005	4166	1258	100	1446
30XW-V368	2165	1005	4166	1258	100	1446
30XW-V358	2300	881	4124	1258	100	1551
30XW-V378	2160	1148	4515	1258	100	1551
30XW-V408	2160	1148	4515	1258	100	1551
30XW-V428	2160	1148	4515	1258	100	1551
30XW-V458	2160	1148	4515	1258	100	1551
30XW-V306	2160	912	4042	1231	100	1419
30XW-V326	2160	933	4088	1258	100	1419
30XW-V356	2160	933	4088	1258	100	1419
30XW-V376	2300	868	4107	1258	100	1536
30XW-V406	2300	868	4107	1258	100	1536
30XW-V426	2300	868	4107	1258	100	1536
30XW-V456	2300	868	4107	1258	100	1536

Notes:

- 1. 4 bolts used to fix chiller, bolt size M20x300.
- 2. User can select 1, 2, 3, 4 or 1', 2', 3', 4' as a group to fix bolts.

Dimension Drawing

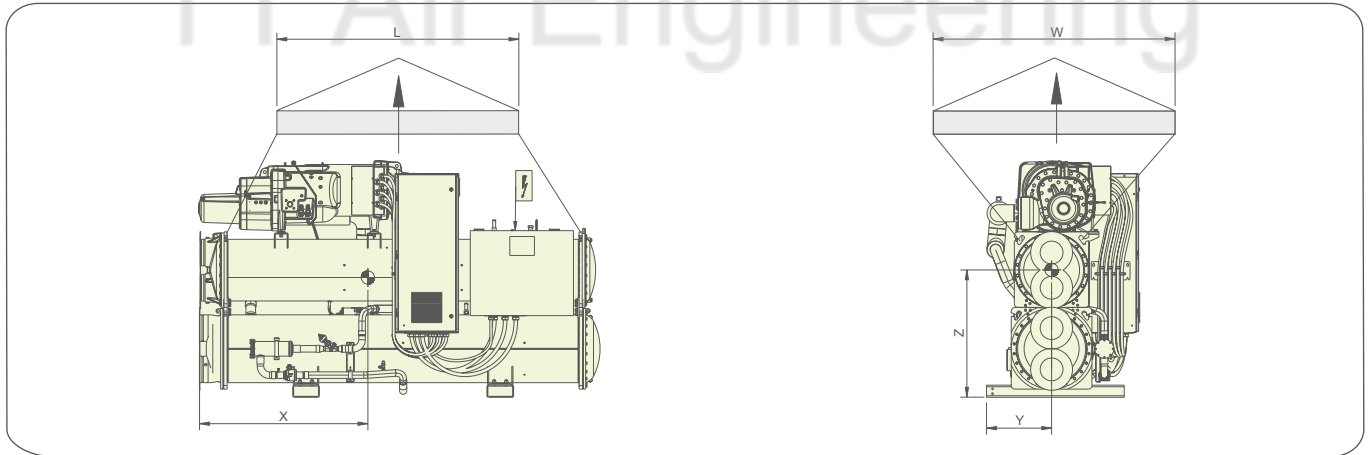

MODEL	X(mm)	Y(mm)	Z(mm)	L(mm) min	W(mm) min
30XW-V160	1447	502	930	2000	1200
30XW-V180	1447	502	930	2000	1200
30XW-V195	1382	615	1045	2000	1200
30XW-V200	1382	615	1045	2000	1200
30XW-V235	1382	615	1045	2000	1200
30XW-V308	1723	605	1198	2000	1200
30XW-V328	1796	605	1438	4500	1600
30XW-V338	1723	598	1209	2000	1200
30XW-V368	1723	598	1209	2000	1200
30XW-V358	1804	605	1448	4500	1600
30XW-V378	2014	605	1422	4600	1600
30XW-V408	2018	603	1423	4600	1600
30XW-V428	2018	603	1423	4600	1600
30XW-V458	1959	608	1553	4600	1600
30XW-V306	1161	602	1142	2000	1200
30XW-V326	1684	602	1149	2000	1200
30XW-V356	1684	602	1149	2000	1200
30XW-V376	1722	602	1612	4500	1600
30XW-V406	1722	602	1612	4500	1600
30XW-V426	1704	613	1599	4500	1600
30XW-V456	1704	613	1599	4500	1600

Notes:

- 1. Each spider bar must with stand unit weight.
- 2. Gravity center must be aligned with lifting bar.
- 3. Loading by lifting lug of condenser is prohibited.

Pressure drop curve 30XW-V units

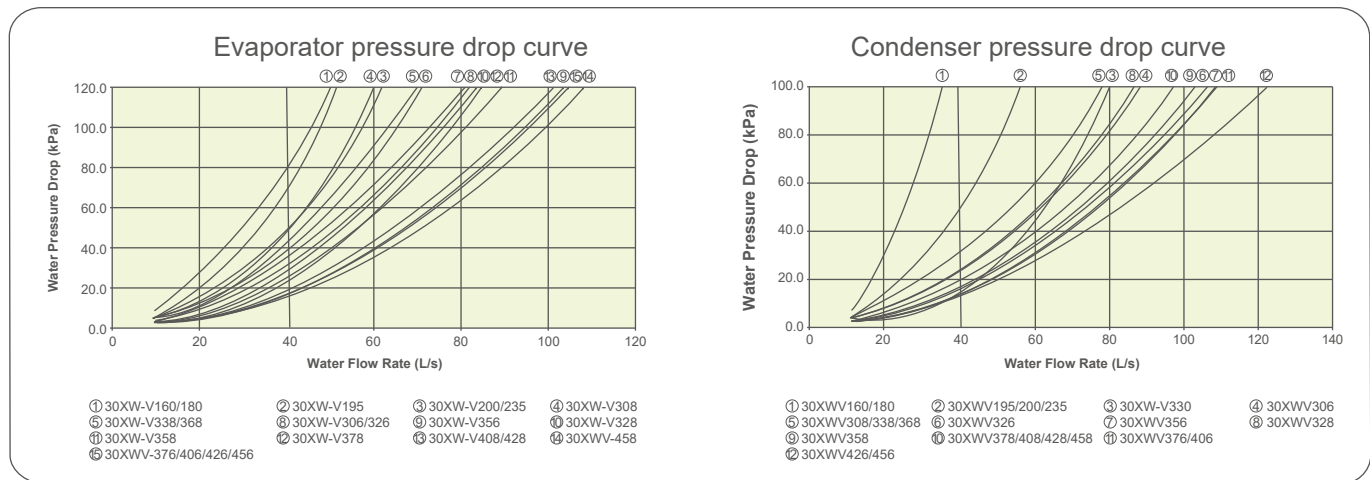

Water flow rate range (L/s)

30XW-V	Evaporator		Condenser	
	Volume(min)*	Volume(max)***	Volume(min)**	Volume(max)***
160	8.4	50.7	5.1	51.1
180	8.4	50.7	5.1	51.1
195	9.6	69.2	7.6	78.7
200	11.4	68.7	7.8	67.9
235	11.4	68.7	7.8	67.9
308	11.4	63.4	8.8	89.7
338	12.7	74.8	8.8	89.7
368	12.7	74.8	8.8	89.7
328	15.1	92.4	10.9	110.0
358	15.9	97.0	12.7	129.1
378	15.9	97.0	12.7	129.1
408	18.9	114.9	12.7	129.1
428	18.9	114.9	12.7	129.1
458	18.9	114.9	12.7	129.1
306	12.7	74.8	8.8	87.1
326	12.7	74.8	10.6	107.7
356	17.4	91.2	11.5	116.6
376	16.4	96.3	11.0	111.5
406	16.4	96.3	11.0	111.5
426	16.4	96.3	12.0	121.7
456	16.4	96.3	12.0	121.7

Note:
 * Based on flow velocity:0.5m/s
 ** Based on flow velocity:0.3m/s
 *** Based on flow velocity:3.05m/s

Recommendations on heat exchange fluids

Filters are required to be installed in water entering side, and water quality analysis periodically implement. Water quality should be maintained within the limits indicated in below table.

Water Characteristics	Quality Limitation
NH ₃	<2 ppm
NH ⁴⁺	<2 ppm
Cl ₂	<1 ppm
Cl ⁻	< 300 ppm
H ₂ S*	<0.05 ppm
SO ₄ ²⁻	< 70 ppm
CO ₂ †	<5 ppm
Fe ²⁺ /Fe ³⁺	<0.2 ppm
O ₂	< 5 ppm

Water Characteristics	Quality Limitation
NO ₃	<100 ppm
Si	< 0.1 ppm
Al	<0.2 ppm
Mn	<0.1 ppm
Hardness	71.2<...<151.3mg/l CaCO ₃
Resistance	>3000ohm.cm
Conductivity	200<...<600µS/cm
Ph	7.5<...<9

Guide Specifications

General description

Factory assembled single piece variable speed water-cooled liquid chiller. Contained within the unit shall be all factory wiring, piping, controls, refrigerant charge (HFC-134a), refrigeration circuits set, screw compressors, variable frequency drive, electronic expansion valves and equipment required prior to field start-up.

Size Range:

161 to 460 Tons (567 to 1619 kW) Nominal

Carrier Model Number:

30XW-V xxx

Part 1 — General

1.01 SYSTEM DESCRIPTION

Microprocessor controlled Variable speed water-cooled liquid chiller utilizing screw compressor, variable frequency drive and electronic expansion valves.

1.02 QUALITY ASSURANCE

- Unit performance shall be rated in accordance with AHRI Standard 550/590.
- Unit shall be designed and constructed to meet GB9237-2001 Mechanical refrigeration system safety requirement and GB5226.1-2002 Safety of machinery-Electrical equipment of machines.
- Unit shall be designed, manufactured and tested in a facility with a quality management system certified ISO 9001 and environmental management system ISO 14001.

1.03 DELIVERY, STORAGE, AND HANDLING

- Unit shall be capable of withstanding 60°C storage without damage, failure, refrigerant loss, or safety risks.
- Chiller should be stored indoors, protected from construction dirt and moisture. An inspection should be conducted under shipping tarps, bags, or crates to be sure water has not collected during transit. Protective shipping covers should be kept in place until machine is ready for installation.

Part 2 — Products

2.01 General:

Factory assembled, single-piece, variable speed water-cooled liquid chiller. Unit sizes 165-235 shall have single independent refrigerant circuit. Unit sizes 330-460 shall have dual independent refrigerant circuit. Contained within the unit cabinet shall be all factory wiring, piping, controls, refrigerant charge (HFC-134a) and special features required prior to field start-up.

2.02 Compressor (s) :

- 06T semi-hermetic twin-screw compressors with internal relief valve and check valve to avoid reverse rotation on shut down.
- Each compressor is equipped with discharge shut-off valve (optional) .
- Compressor capacity control is ensured by successive use of speed variation (using a variable frequency drive) and swept volume variation at the screws (ensured by the slide valve) , capable of reducing compressor capacity down to 20% of full load. Compressor shall start in unloaded condition.
- Motor shall be cooled by suction gas and protected by internal winding temperature sensors. Compressor bearings shall be designed for minimum 73000 hours at maximum operating conditions.
- Lubrication oil system shall include pre-filter and external filter capable of filtration to 5 microns.

2.03 Evaporator:

- Evaporator shall be manufactured, tested and stamped in accordance with the NB/T 47012-2010(JB/T 4750) and TSG R004-2009.
- The maximum refrigerant-side working pressure will be 1500 kPa and the maximum waterside pressure will be 1000 kPa (1600, 2100kPa as an option).
- The evaporator shall be mechanically cleanable, shell-and-tube type with removable heads.
- Tubes shall be internally and externally grooved, seamless-copper, and shall be rolled into tube sheets.
- Shall be equipped with victaulic fluid connections or flanged fluid connections.
- Shell shall be insulated with 19 mm closed-cell foam with a maximum K factor of 0.28. Evaporator thermal insulation shall be factory fitted.
- The evaporator shall have a drain and vent in each head.

Guide Specifications

- ✎ The evaporator shall incorporate an active refrigerant level control system to ensure optimum heat transfer performance under all load conditions.
- ✎ Evaporator shall be fitted with electronic auto setting water flow switch.

2.04 Condenser:

- ✎ Condenser shall be manufactured, tested and stamped in accordance with the NB/T 47012-2010(JB/T 4750) and TSG R004-2009.
- ✎ The maximum refrigerant-side working pressure will be 1500 kPa and the maximum waterside pressure will be 1000 kPa (1600, 2100kPa as an option).
- ✎ The condenser shall be mechanically cleanable shell-and-tube type with removable heads.
- ✎ Tubes shall be internally and externally grooved, seamless-copper, and shall be rolled into tube sheets.
- ✎ Shall be equipped with victaulic fluid connections or flanged fluid connections.
- ✎ The condenser shall have a drain and vent in each head.

2.05 Refrigeration Components:

- ✎ Refrigerant circuit components shall include, compressor, oil separator, high and low side pressure relief devices, compressor discharge shutoff valves (optional), refrigerant liquid sub assembly line, filter driers, moisture indicating sight glasses, long stroke electronic expansion device, and complete operating charge of both refrigerant HFC-134a and compressor oil.
- ✎ To facilitate service and maintenance and avoid refrigerant charge transfers, it must be possible to isolate the following components and systems independently: filter driers, oil filters.

2.06 Carrier SmartView™ colorful screen user interface:

This Carrier SmartView™ colorful screen user interface allow customer to select menu or action by pressing directly on the screen. It is recommended to use a pen for the navigation via the touch screen. It prevents screen maintenance and allows more precision during the selections.

2.07 Variable frequency drive:

30XW-V/30XW-V Heating units are equipped with a frequency variator that permits compressor capacity adjustment by varying the motor speed in the 30-60 Hz frequency range. The compressor drive uses power supply waveform generation with variable frequency and voltage, generated by pulse width modulation (PWM).

Compressor start-up and stopping and the frequency setting for the operating range is only by RS485 communication in the LEN protocol via the Carrier controller. One of the other frequency variator functions is to ensure the unit safety stop function using wired pressure switches at the digital drive inputs.

2.08 Controls:

Unit controls shall include the following minimum components:

- ✎ Microprocessor with non-volatile memory, picture guided unit/operator interface, the LOCAL/OFF/REMOTE/CCN selector and a display with multiple language capability.
- ✎ Pressure sensors shall be installed to measure suction, discharge and oil pressure.
- ✎ Thermostats shall be installed to measure cooler entering and leaving temperatures (on cooler and condenser side).

Unit controls shall include the following functions:

- ✎ Automatic change-over and cycling of compressors to equalize running hours and number of starts.
- ✎ EXV control, based on throttling optimizes evaporator charging, ensuring condenser superheat and sub-cooling.
- ✎ Capacity control based on leaving chilled fluid temperature with return fluid temperature sensing.
- ✎ Limit the chilled fluid temperature pull-down rate at start-up to an adjustable range of 0.1 C to 1.1 C per minute to prevent excessive demand spikes at start-up.
- ✎ Enable reset of leaving chilled water temperature according to the return water temperature or by means of a 0-10V signal.
- ✎ Provide a dual set point for the leaving chilled water temperature activated by a remote contact closure signal or by the built in time clock.
- ✎ Enable a 2-level demand limit control (between 0 and 100%) or a maximum current drawn limit activated by a remote contact closure or by the built in time clock.
- ✎ Control evaporator water pump and the condenser pump.
- ✎ Allow two time scheduling programs to enable unit start-up control, demand limit and set-point changes.
- ✎ Enable lead lag control of two chillers running in series or parallel.

Guide Specifications

2.09 Diagnostics:

- ✔ Display module shall be capable of displaying set points, system status including temperatures, pressures, current for each compressor, run time and percent loading.
- ✔ The control system shall allow a quick test of all machine elements to verify the correct operation of every switch before the chiller is started.

2.10 Safeties:

- ✔ Unit shall be equipped with all necessary components, and in conjunction with the control system shall provide the unit with protection against the following:
 - Reverse rotation.
 - Low chilled water temperature.
 - Low oil pressure (per compressor).
 - Current imbalance.
 - Compressor thermal overload
 - Automatic compressor unloading in case of excessive condensing temperature
 - High pressure.
 - Electrical overload.
 - Loss of phase.
 - Variable speed drive failure
- ✔ Control shall provide separate general alert (minor incident) and alarm (circuit down) remote indication.

2.11 Operating Characteristics:

- ✔ Unit shall be capable of starting with 13 °C entering water temperature to the condenser.
- ✔ Unit shall be capable of starting with 35 °C entering water temperature to the evaporator.

2.12 Electrical Characteristics:

- ✔ Unit shall operate on 3-phase power supply (380V-3-60Hz) without neutral.
- ✔ Control voltage shall be supplied by a factory-installed transformer.
- ✔ Unit shall be supplied with factory-installed electrical disconnect/isolator switch integrating main fuses.
- ✔ Unit shall have a factory installed variable frequency drive as standard to well control the electrical inrush current below maximum operation current.

2.13 Option Features:

- ✔ Energy Management Module:
A factory or field installed module shall provide the following energy management capabilities: 4 to 20 mA signals for leaving fluid temperature reset, cooling set point reset or demand limit control; 2-point demand limit control (from 20 to 100%) activated by a remotcontact closure; and discrete input for "Ice Done" indication for ice storage system interface.
- ✔ LON Translator Control:
Unit shall be supplied with factory or field-installed interface between the Chiller and a Local Operating Network (LON, i.e., Lon Works FT-10A ANSI/EIA-709.1).
- ✔ Medium Temperature Brine:
Unit shall be factory modified to start and operate at leaving chilled fluid temperatures below 3.3 °C . Chiller shall be equipped with condenser water flow switch.
- ✔ Marine Waterboxes:
Marine waterboxes shall provide water piping connections extending from the side of the waterbox (as opposed to extending from the end of the waterbox). This option also includes a removable bolt on waterbox cover allowing access to the heat exchanger tubes without breaking the existing field piping. This option is available for both the evaporator and condenser.
- ✔ Heat machine:
Heat machine condensers shall include factory-installed thermal insulation on the condenser, condenser flow switch and leaving water temperature sensor. Heat machine units require field-installed thermal insulation on waterbox heads because of high temperature.



Carrier improves the world around us; Carrier improves people's lives; our products and services improve building performance; our culture of improvement will not allow us to rest when it comes to the environment.

TT Air Engineering



www.carrier.com

The Manufacturer reserves the right to change any product specifications without prior notices
© All Rights Reserved Carrier

Version:	CAT_30XWV_E-202106-12
Supersede:	CAT_30XWV_E-202008-11
Effective date:	Jun, 2021